

# **DINI ARGEO** Scales - Weighing systems

SCALES



WEIGHING  
SYSTEMS



























SOFTWARE



GENERAL CATALOGUE



# TABLE OF CONTENTS

	<b>COMPANY PROFILE</b>	<b>2</b>
	<b>CAP 1 SCALES</b>	<b>8</b>
	LABORATORY SCALES	10
	MULTIFUNCTION SCALES	14
	SCALES FOR SPECIFIC APPLICATIONS	20
	VEHICLE INSPECTION	24
	PALLET WEIGHING SCALES	26
	FORKLIFT TRUCK SCALES	28
	CRANE/OVERHEAD CRANE SCALES	30
	<b>CAP 2 FUNCTIONALITY</b>	<b>32</b>
	MULTIFUNCTION WEIGHT INDICATORS	34
	PROGRAMMABLE WEIGHT INDICATORS	36
	ACCESSORIES FOR WEIGHT INDICATORS	38
	COMPLETE SYSTEMS FOR:	
	• WEIGHING AND DATA TRANSFER	40
	• WEIGHING AND COUNTING	42
	• VEHICLE WEIGHING AND MANAGEMENT	44
	• WEIGHING AND QUALITY CONTROL OF PRE-PACKAGED PRODUCTS	46
	• WEIGHING, DATA MANAGEMENT AND LABEL PRINTING	48
	• WEIGHING AND MANUAL DRIVEN DOSAGE	50
	• VEHICLE BARYCENTER WEIGHING AND CHECKING	52
	• VEHICLE DYNAMIC WEIGHING	54
	<b>CAP 3 SOFTWARE</b>	<b>56</b>
	INTEGRATED SOLUTIONS	58

# COMPANY PROFILE

production  
design  
quality control

## Scales and weighing systems



Dini Argeo, a company which has been producing scales and weighing systems since 1846, has been registered since 02/04/1906 at the Registry of Metric Manufacturers provided by the Royal Decree nr. 226 of 12/06/1902.



**Dini Argeo** is a company specialising in the design and manufacturing of scales and weighing systems worldwide-known for quality and reliability.

The solutions created by **Dini Argeo** are suitable for any industrial weighing application:

- reading, collection, processing and transfer of weight data
- simple, sequential, simultaneous dosage, in-loading or unloading, single or multicomponent dosage, continuous dosage on belt conveyors or loss-in-weight feeding.
- Weighing in areas endangered by potentially explosive atmospheres (ATEX)
- piece counting, labelling
- control of production lines, statistical check of prepackaged products
- logistics weighing (pallet scales, pallet truck scales, weighing forks for lift trucks, crane scales)
- vehicle weighing (weighbridges, wheel weighers, static and dynamic axle weighers).

A full range of interfaces and communication protocols is available as standard thus making Dini Argeo products easily integrable into industrial automation and processing for the development of OEM systems with customisable functions.



Dini Argeo has obtained the Quality Management System certification according to the BS EN ISO 9001:2015 for the design, manufacture and after sales service in respect of measuring instruments, scales and weighing systems, components and software.

Dini Argeo produces approved or approvable instruments for a legal-for-trade use following the European regulation EN 45501 and the directive 2014/31/EU.

The metrological marking indicates that the instrument is covered by a type approval certificate, released by an European notified body, that validates the idoneity for a legal use. This approval is fundamental for all the instrument legal-for-trade uses, in relationship with third parties.

Dini Argeo is an ATEX notified company, in accordance with the 94/9/CE (Annex IV) Directive, since 20/04/2016 with 2014/34/UE directive and therefore authorised to produce and market equipment marked by Ex-symbol intended for use in potentially explosive atmospheres.



# Dini Argeo Group

## A COMPREHENSIVE SERVICE

**Dini Argeo** offers the customer a complete service ranging from the working out of customised solutions and supply of weighing components to the development of software for PC and communication networks, calibration and approval services of OEM systems. Dini Argeo has grown into a group with a strong international calling, composed of subsidiaries in Europe and Asia, alongside a distribution and customer service network in more than 70 countries around the world. Dini Argeo works in cooperation with the other companies of the Group, which are market leaders in their specific field of activity:

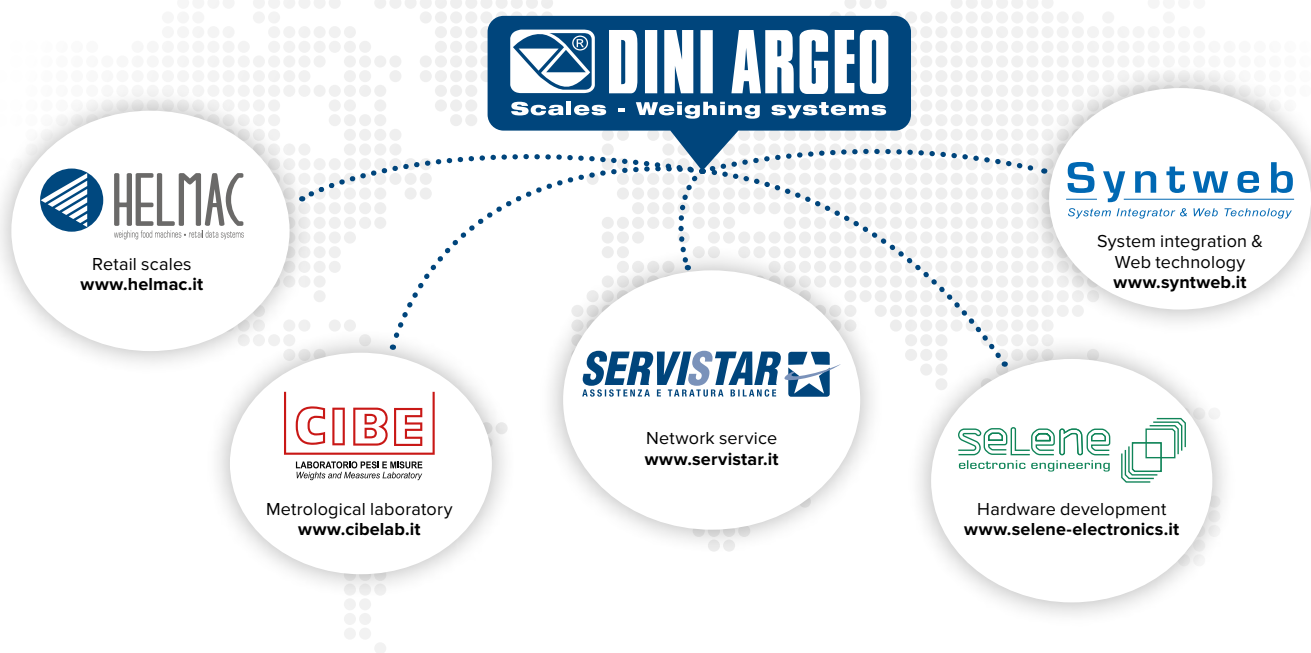

Dini Argeo manufactures non-automatic weighing instruments in conformity with the 2014/31/EU Directive. The DG0126 mark states the instrument is subject to the EC verification by the manufacturer according to the Certificate of EC approval of the Production Quality Assurance System.

Dini Argeo produces instruments in compliance with the requirements laid down by the recommendations of the International Organization of Legal Metrology (OIML):

- Load cells approved to OIML R60
- Non-automatic weighing instruments approved to OIML R76
- OIML R134 approved dynamic weighers for vehicle transiting at a low speed.
- OIML R51 approved "start/stop" automatic catchweigher on belt conveyors.
- Gravimetric filling instruments approved to OIML R61.

Dini Argeo obtained the GOST-R certification ensuring that its instruments comply with the regulations provided for by the Russian Federation.

# TYPE-APPROVAL SERVICES



## Scales approved for

### LEGAL-FOR-TRADE

#### OUR LEGAL METROLOGY SERVICES

Those scales which are intended for use in commercial weighing applications where product is sold by weight must have an **APPROVED weighing system** according to EN45501 (not automatic weighing instruments) or to MID (automatic weighing instruments).



The whole range of Dini Argeo products herein marked with a **green M-symbol** are available in CE-M approved versions, certified and suitable for legal-for-trade use.

Each approved system supplied by Dini Argeo may also be equipped with a fiscal memory (alibi memory) which certifies the weight read on the display as well as the weight transmitted to the printer or to the company's IT network.

## Type-approval services



Type-approval to **EN 45501 - 2014/31/EU** for non-automatic weighing instruments



Type-approval to **MID R61** for automatic weighing instruments on belt conveyors



# CALIBRATION SERVICES

A certificate of calibration, expression of certainty in your measurement

Irrespective of whether weighing instruments are for legal-for-trade use or commercial applications or integrated into production and logistic processes, ascertaining the measurement accuracy is a **guarantee of quality and time-money saving.**

Dini Argeo offers a full range of **calibration services** for weighing instruments in compliance with ISO9001 and ISO17025 standards.

Calibration services



ISO 17025

Calibration according to ISO 17025 (DKD/DAKKS, SIT/ACCREDIA, UKAS, COFRAC, etc.) for scales or dynamometers



ISO 9001

Calibration according to ISO 9001 for industrial weighing instruments



# SOLUTIONS FOR ATEX AREAS



**DINI ARGEO is a certified company** authorised to manufacture and sell weighing instruments intended for use in industrial potentially explosive areas according to ATEX standards.









**CLASSIFICATION OF ATEX AREAS**  
Are there any ATEX areas in your company?



## Example of activities

**WHICH MAY PRODUCE EXPLOSIVE MIXTURES DURING A PROCESSING CYCLE**

	<b>MANUFACTURING AND PROCESSING OF:</b>	Plastic, rubber, paper, leather, fibreglass, glass, wood
	<b>METALLURGY - STEEL INDUSTRY</b>	Iron, aluminium foundries, small metal parts
	<b>CHEMISTRY</b>	Chemical analysis laboratory, pharmaceutical industry, ceramics industry, pesticide production plant, paintings
	<b>WASTE</b>	Landfill sites, incinerators, waste disposal and treatment plants, purification installations
	<b>TEXTILE INDUSTRY</b>	Yarn weaving
	<b>FOOD INDUSTRY</b>	Baking ovens, mills
	<b>BUILDING</b>	Cement factories, electricity in building

The products developed by **DINI ARGEO** cover the majority of industrial weighing applications.



The product categories marked with the **symbol "Ex"** are available in a version suitable for use in ATEX environments.



# WEB

**DID YOU FIND THE SOLUTION  
YOU WERE LOOKING FOR  
AND  
would you like  
more  
information**



**Would you like  
to discover  
the full range  
OF SOLUTIONS  
AND PRODUCTS  
OFFERED BY  
Dini Argeo**



**WOULD YOU LIKE TO LET  
YOUR SPECIAL REQUEST  
be analysed  
by a technical  
skilled staff**



Visit our website **[www.diniargeo.com](http://www.diniargeo.com)**

for full product, technical information and advice  
for your weighing applications.



**Enter**  
THE INFORMATION area  
and send the request form  
directly from the site.



**Download**  
Dini Argeo weighing apps  
free of charge  
from **Google play**.

*We'd be very pleased to help you choose the weighing system most suited to your needs.*



INDUSTRY  
(ALL SECTORS)



METALWORKING  
STEEL INDUSTRY



COMMERCIAL AND  
DISTRIBUTION



TRANSPORT  
AND LOGISTICS



PLATFORMS  
FOR LOGISTICS



FOUNDRIES,  
STEEL PLANTS  
AND DRAWING  
PLANTS



AGRI-FOOD  
INDUSTRY



MEAT-PROCESSING  
INDUSTRY



RAW MATERIALS



APPROVED TO OIML



APPROVED FOR  
LEGAL-FOR-TRADE USE



AVAILABLE IN  
ATEX VERSIONS  
FOR EXPLOSIVE ENVIRONMENTS



## CHAPTER 1

### SCALES

A specific scale  
for every need.

<b>LABORATORY SCALES:</b> analytical balances, precision balances and moisture analysers, ideal for use in laboratories, chemical and pharmaceutical industry	PAGE 10
<b>MULTIFUNCTION SCALES</b> ideal for use in production departments, laboratories, retail shops, warehouse and depot, receiving, control and distribution of raw materials, forwarding	PAGE 14
<b>SCALES FOR SPECIFIC APPLICATIONS</b> ideal for use in production departments, goods forwarding and receiving, butchering and seasoning	PAGE 20
<b>AXLE WEIGHERS FOR VEHICLE INSPECTION</b> ideal for use in goods and raw materials receiving and forwarding departments, overloads checking, waste disposal and recycling	PAGE 24
<b>SCALES FOR WEIGHING GOODS ON PALLETS</b> ideal for use in production departments, goods receiving and forwarding, warehouse	PAGE 26
<b>WEIGHING SCALES FOR FORKLIFT TRUCKS</b> ideal for use in production departments, goods receiving and forwarding, warehouse	PAGE 28
<b>WEIGHING SCALES FOR CRANES AND OVERHEAD CRANES</b> ideal for use in production departments, goods receiving and forwarding, warehouse	PAGE 30



## Analytical scales for laboratory

Multifunctional high-precision balances suitable for laboratory and industrial use. Paired with an advanced weight indicator, they are ideally suited for microdosing, checkweighing, labelling applications by network data sharing.

A robotised self-calibration system through internal sample weight keeps weighing accuracy unchanged for many years to come.

CAPACITY (g)	PLATE (mm)	DIVISION (g)	
		STANDARD	APPROV*
120	Ø 80	<b>0,0001</b>	0,001
220	Ø 80	<b>0,0001</b>	0,001



## Precision scales

Precision scales ideal for use in laboratory and industrial application. Combined with an advanced weight indicator, they are suitable for microdosing, checkweighing, labelling applications by network data sharing.

These scales can be equipped with a manual calibration system through internal sample weight.

CAPACITY (g)	PLATE (mm)	DIVISION (g)	
		STANDARD	APPROV*
420	Ø 118	<b>0,001</b>	0,01
620	Ø 118	<b>0,001</b>	0,01
2200	180x160	<b>0,01</b>	0,1
4200	180x160	<b>0,01</b>	0,1

CH. 2 FUNCTIONALITY expandable through an additional advanced indicator



## Stainless steel precision scales

Their stainless steel partial or complete structure makes these scales ideal for use in harsh environments requiring strict hygiene. Especially designed for statistical check of pre-packaged products or microbatching.



CAPACITY (g)	PLATE (mm)	DIVISION (g)	
		STANDARD	APPROV*
320	Ø 140	<b>0,01</b>	0,01
620	Ø 140	<b>0,01</b>	0,01
3200	190x190	<b>0,1</b>	0,1
6200	190x190	<b>0,1</b>	0,1
8200	190x190	<b>0,1</b>	0,1
15000	190x190	<b>0,1</b>	1
22000	400x350	<b>0,1</b>	1
32000	400x350	<b>0,1</b>	1

## Moisture analysers

These high-precision balances are suitable for determining the moisture content in materials through a special halogen lamp drying system.



CAPACITY (g)	DIVISION (g)
	STANDARD
60	<b>0,001</b>
210	<b>0,001</b>

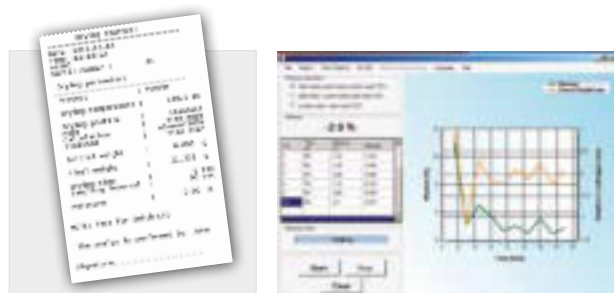



## Stainless steel laboratory scales

High-resolution precision scales ideal for laboratory and chemical/pharmaceutical industry. Entirely made of stainless steel, they are protected against dust, damp and water moisture. A RED LED display simplifies reading even in low temperature environments.

CAPACITY (kg)	PLATE (mm)	DIVISION (g)	
		STANDARD	APPROV* CE M
2/10	190x220	0,1/1	-
6,5	190x220	0,1	-
3/6	190x220	-	0,5/1
6/12	190x220	-	1/2



## Compact scales for laboratories and industry

Watertight compact multifunction scales, particularly suitable for industrial laboratories and burdensome working environments.

Characterized by their compact dimensions and ergonomic design, they are fully realized in aluminium alloy, in order to guarantee sturdiness and weighing precision.

The innovative integrated calibration weight allows to check periodically the correct functioning of the scale.

CAPACITY (kg)	PLATE (mm)	DIVISION (g)	
		STANDARD	APPROV* CE M
6000	190x190	0.1	1



### Stainless steel compact scales with LCD display

These scales are characterized by the big dimensions of the loading plate, which allows to weigh fruit crates, packages and cumbersome objects easily. The colour LCD display integrates the check weight function, changing the colour according to the weighing result (scarce, good or abundant).



CAPACITY (kg)	PLATE (mm)	DIVISION (g)	
		STANDARD	APPROV* $\text{CE M}$
15/30	250x340	<b>5/10</b>	5/10

### Compact stainless steel scales with touch screen display

Evolved version, specific for applications such as counting, manual dosage, labeling and statistic control of prepackaged goods. This scale offers use simplicity and a wide range of interfaces, in order to communicate with the main computer devices.

Moreover, it offers the possibility to connect additional bench scales, floor ones, or very-high precision scales for sampling of little dimensions components.



CAPACITY (kg)	PLATE (mm)	DIVISION (g)	
		STANDARD	APPROV* $\text{CE M}$
3/6	250x340	<b>0,5/1</b>	0,5/1
12/30	250x340	<b>2/5</b>	2/5





CH. 2 Go to chapter FUNCTIONALITY and choose **the indicator** most suited to your needs!

## Bench scales for small objects

Scales equipped with a round pan, suitable for weighing small objects. The removable stainless steel “double face” pan is easy to clean and the spirit level level and the adjustable supporting feet allow for a correct installation also on inclined shelves.

CAPACITY (kg)	PLATE (mm)	DIVISION (g)		
		STANDARD	APPROV*	HIGH RESOL.
1,5	Ø 178	0,2	0,5	0,05
3	Ø 178	0,5	1	0,1
6	Ø 178	1	2	0,2
15	Ø 178	2	5	0,5

\* On request, depending on the model: multi scale: 3000+3000e, 6000e, 6000+6000e

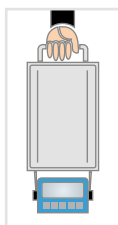

CH. 2 Go to chapter FUNCTIONALITY and choose **the indicator** most suited to your needs!

## Compact portable scales

Extremely versatile scales, easily transportable and ideal for instant weighing anywhere. Especially valued by the agricultural industry to weigh fruits and vegetables during harvest or in warehouse for inventory or stocktaking. They also allow to save weighing readings to a USB flash drive for further processing.

The structure is entirely made of AISI 304 stainless steel.

CAPACITY (kg)	PLATE (mm)	DIVISION (g)		
		STANDARD	APPROV*	HIGH RESOL.
6/15	365x235	2/5	2/5	0,5
15/30	365x235	5/10	5/10	1
12/30	365x235	2/5	2/5	-

\* On request, depending on the model: multi scale: 3000+3000e, 6000e, 6000+6000e



indicator installable on both sides

removable indicator for suspended loads



**CH. 2**

Go to chapter FUNCTIONALITY and choose **the indicator** most suited to your needs!

## Bench/floor scales

Easy-to-use, versatility and sturdiness are their distinguishing features. Equipped with non-slip adjustable feet, spirit level and protection against electrostatic discharge.

CAPACITY (kg)	PLATE (mm)								DIVISION (g)				
	230x330	300x300	330x330	400x400	400x500	500x500	500x600	600x600	700x700	800x800	STANDARD	APPROV*	HIGH RESOL.
3	•										0,5	1	0,1
6	•	•									1	2	0,2
15		•	•	•							2	5	0,5
30		•	•	•	•	•					5	10	1
60				•	•	•	•	•			10	20	2
150				•	•	•	•	•	•		20	50	5
300							•	•	•	•	50	100	10
600									•	•	100	200	20

\* On request, depending on the model: multi scale: 3000+3000e, 6000e, 6000+6000e



AVAILABLE IN FINISHING



GALVANIZED



STAINLESS

**CH. 2**

Go to chapter FUNCTIONALITY and choose **the indicator** most suited to your needs!

## Floor scales

Made of high-quality materials these scales are composed of oversized load cells, thus ensuring durability and weighing high-accuracy. They can be installed above-ground, with ramps, as well as flush-floor.

CAPACITY (kg)	PLATE (mm)								DIVISION (g)			
	600x600	1000x1000	1000x1250	1250x1250	1250x1500	1500x1500	1500x2000	1500x2500	2000x2500	STANDARD	APPROV*	HIGH RESOL.
150	•									20	50	-
300	•	•	•	•						50	100	20
600		•	•	•	•	•	•			100	200	50
1500		•	•	•	•	•	•			200	500	100
3000					•	•	•	•	•	500	1000	200
6000							•	•	•	1000	2000	500
10000								•	•	2000	5000	1000

\* On request, depending on the model: multi scale: 3000+3000e, 6000e, 6000+6000e

## Low-profile floor scales

Low-profile scales with on/off ramps for an accurate weigh measurement of the load carried by forklifts and manual pallet trucks. Ideal for use in warehouses, storage and waste separation areas.

CAPACITY (kg)	PLATE (mm)				DIVISION (g)		
	1000x1250	1050x1250	1250x1500	1300x1500	STANDARD	APPROV*	HIGH RESOL.
600	•		•		100	200	50
1500	•		•		200	500	100
3000		•		•	1000	1000	-

\* On request, depending on the model: multi scale: 3000+3000e

CH. 2 Go to chapter FUNCTIONALITY and choose **the indicator** most suited to your needs!

## Pallet-weighing scales

Sturdy and heavy-duty pallet-weighing scales equipped with oversized load cells. Sizes optimised to the Eur-pallet dimensional standards.

CAPACITY (kg)	SIZE (mm)		DIVISION (g)		
	1263x840xh85	1385x800xh85	STANDARD	APPROV*	HIGH RESOL.
600		•	100	200	50
1500	•	•	200	500	100
3000	•	•	500	1000	-

\* On request, depending on the model: multi scale: 3000+3000e

CH. 2 Go to chapter FUNCTIONALITY and choose **the indicator** most suited to your needs!

## STAINLESS steel bench/floor scales

The STAINLESS steel structure and the load cell protected against water and dust make these scales ideal for use in harsh environment requiring strict hygiene. Easy-to-use, versatility and sturdiness are their distinguishing features. Equipped with non-slip feet, spirit level and protection against static discharge.

CAPACITY (kg)	PLATE (mm)							DIVISION (g)				
	230x330	300x300	330x330	400x400	400x500	500x500	500x600	600x600	700x700	STANDARD	APPROV*	HIGH RESOL.
3	•									0,5	1	0,2
6	•	•	•							1	2	0,5
15	•	•	•	•						2	5	1
30		•	•	•	•					5	10	2
60				•	•	•	•	•		10	20	5
150				•	•	•	•	•		20	50	10
300						•	•	•		50	100	20
600								•		100	200	50

\* On request, depending on the model: multi scale: 3000+3000e, 6000e, 6000+6000e

CH. 2 Go to chapter FUNCTIONALITY and choose **the indicator** most suited to your needs!



**CH. 2** Go to chapter FUNCTIONALITY and choose **the indicator** most suited to your needs!

## STAINLESS STEEL floor scales

Made of high-quality materials these scales are composed of oversized load cells, thus ensuring durability and weighing high-accuracy. They can be installed above-ground, with ramps, as well as flush-floor.

CAPACITY (kg)	PLATE (mm)										DIVISION (g)		
	600x600	800x800	1000x1000	1000x1250	1250x1250	1250x1500	1500x1500	1500x2000	1500x2500	2000x2500	STANDARD	APPROV*	HIGH RESOL.
150	•										20	50	-
300	•	•	•	•	•						50	100	20
600		•	•	•	•	•	•	•			100	200	50
1500			•	•	•	•	•	•			200	500	100
3000						•	•	•	•		500	1000	200
6000								•	•	•	1000	2000	500
10000									•	•	2000	5000	1000

\* On request, depending on the model: multi scale: 3000+3000e, 6000e, 6000+6000e



**CH. 2** Go to chapter FUNCTIONALITY and choose **the indicator** most suited to your needs!

## STAINLESS STEEL Low-profile floor scales

Low-profile scales with on/off ramps for an accurate weight measurement of the load carried by forklifts and manual pallet trucks. Ideal for use in warehouses, storage and waste separation areas, hospitals and chemical and pharmaceutical industry.

CAPACITY (kg)	PLATE (mm)		DIVISION (g)		
	1000x1250	1250x1500	STANDARD	APPROV*	HIGH RESOL.
600	•	•	100	200	50
1500	•	•	200	500	100

\* On request, depending on the model: multi scale: 3000+3000e



**CH. 2** Go to chapter FUNCTIONALITY and choose **the indicator** most suited to your needs!

## STAINLESS STEEL pallet-weighing scales

Sturdy and heavy-duty pallet-weighing scales equipped with oversized load cells. The sizes are optimised to the Eur-pallet dimensional standards.

CAPACITY (kg)	SIZE (mm)	DIVISION (g)		
		STANDARD	APPROV*	HIGH RESOL.
600	1385x800xh75	100	200	50
1500	1385x800xh75	200	500	100
3000	1385x800xh75	500	1000	-

\* On request, depending on the model: multi scale: 3000+3000e

CH. 2 Go to chapter FUNCTIONALITY and choose **the indicator** most suited to your needs!



## Portable scales on wheels

Real mobile weighing stations with weight indicator, platform, label applicator, bar code reader and many other accessories to communicate with the company information system. Available in painted or STAINLESS steel.

	LOWER LOAD PLATFORM	UPPER LOAD PLATFORM
PLATFORM (mm)	LOAD PLATFORM HEIGHT (mm)	
400x400, 400x500	260	600
600x600	270	600

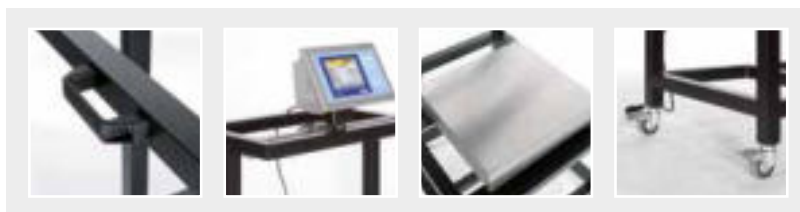

CH. 2 Go to chapter FUNCTIONALITY and choose **the indicator** most suited to your needs!



## Portable multi-platform weighing system

Range of complete multi-balance compact weighing stations, designed for optimising the installation of the weighing system, thus allowing to save space and to simplify the system handling in the working area. Available in painted or STAINLESS steel versions.

PLATFORM ON UPPER SHELF (mm)	PLATFORM ON LOWER SHELF (mm)
230x330, 330x330	400x400, 400x500, 500x600, 600x600

## ACCESSORIES



### Floor support columns

Made of painted steel or stainless steel, they are lightweight, easy-to-handle as well as firm-based and sturdy. Ideal for use in industrial environments. Due to removable adjustable feet they can be firmly put on any kind of surface, fixed to the floor or, by replacing the feet with simple castor wheels, easily moved for instant weighing anywhere.

HEIGHT (mm)

800



### Columns and brackets for compact solutions

Easy-to-install, firm-based and robust, they make the system compact and easy-to-handle. The columns are especially used for lifting up the indicator to a higher position, protecting it against dirt, dust and moisture.

COLUMNS HEIGHT (mm)

350, 500, 700



### Painted or STAINLESS steel raising frames for platforms

Suitable for raising the load platform, facilitating weighing operations. Available in painted or STAINLESS steel versions.

FOR LOAD PLATFORM (mm)

400x400

HEIGHT (mm)

600

600x600

600

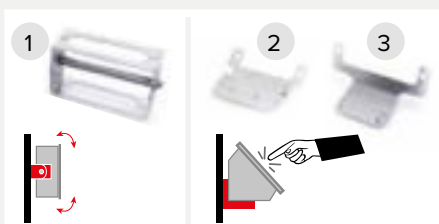

### Fixing brackets for weight indicators

Made of STAINLESS steel, they allow you to easily fix the indicator to the wall or to any vertical surfaces. Available also with adjustable inclination.

1. Adjustable inclination bracket.
2. Weighing platform in-built bracket.
3. Fixed inclination wall bracket.



### Frames for flush-floor installation

Mounted directly inside the pit, they optimise the installation of the platform for a correct operation. Available in painted or STAINLESS steel versions.

FOR LOAD PLATFORM (mm)

600x600, 1000x1000, 1000x1250,  
1250x1250, 1250x1500,  
1500x1500, 1500x2000, 1500x2500, 2000x2500

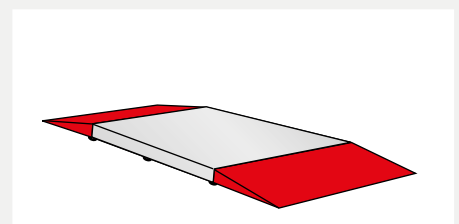

### Ramps for floor scales

Suitable for non-pit mounted platform to move up/down pallet trucks and hand powered forks. A special system allows for fixing it to the platform or to the floor. Available in painted or STAINLESS steel versions.

RAMP SIZES (mm)

1000x900, 1250x1100, 1500x1100

## Scales for iron and metal sheet weighing

Scales suitable for weighing metal section bars, rods, tubes and metal sheets in industrial and commercial applications. Standard version manufactured pursuant to OIML R-76 / EN 45501 regulation. Weighing platforms available also in CE-M APPROVED version.

CAPACITY (kg)	LOAD PLATFORM (mm)				DIVISION (g)	
	L1000xP2000xh1650	L1500xP2000xh1650	L1000xP3000xh1650	L1500xP3000xh1650	STANDARD	APPROV* CE M
1500	•	•	•		200	500
3000	•	•	•		500	1000
600			•	•	1000	2000

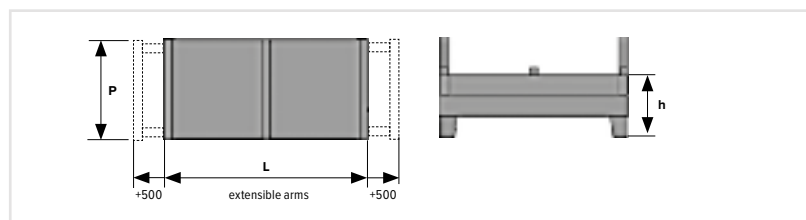

CH. 2 Go to chapter FUNCTIONALITY and choose the indicator most suited to your needs!

## Checkweighers for conveying lines with approved “stop & go” dynamic checkweighing

Compact, reliable and accurate +/- checkweighing systems. Integrated into production and/or logistic conveying lines they guarantee quality and quantity of the output product. Static or dynamic operation mode. Structure made of painted or IP65 STAINLESS steel.

CAPACITY (kg)	800x500	1000x650	DIVISION (g)	PACKS/min
	h = from 450 to 850			
	LOAD PLATFORM (mm)		STANDARD	
6	•		2	from 10 to 60
15	•	•	5	from 10 to 60
30	•	•	10	from 10 to 60

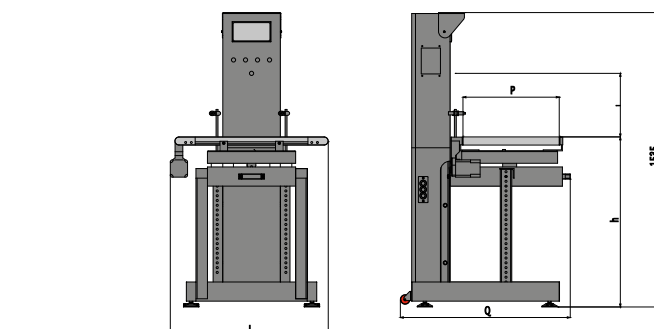



## Overhead rail scales

These low-profile overhead rail scales can be easily keyed to any rail conveying system, already existing or new. Manufactured in compliance with the requirements provided for by the regulations on equipment to be installed inside food environments they consist of hypersanitizable AISI 304 stainless steel structure and approved watertight oversized load cells ensuring sturdiness and durability over time.

CAPACITY (kg)	L300	L600	DIVISION (g)	
	WEIGHING AREA (mm)		STANDARD	APPROV*
150	•		50	50
300	•	•	100	100
600		•	200	200

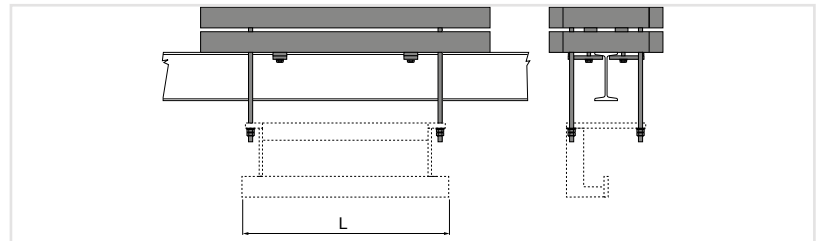

**CH. 2**

Go to chapter **FUNCTIONALITY** and choose **the indicator** most suited to your needs!

## Wall quarter-weighing scales

These scales offer the possibility of weighing quarters by using a load platform or a weighing hook. Manufactured in compliance with the requirements provided for by the regulations on equipment to be installed inside food environments they consist of hypersanitizable AISI 304 stainless steel structure and approved watertight oversized load cell ensuring sturdiness and durability over time.

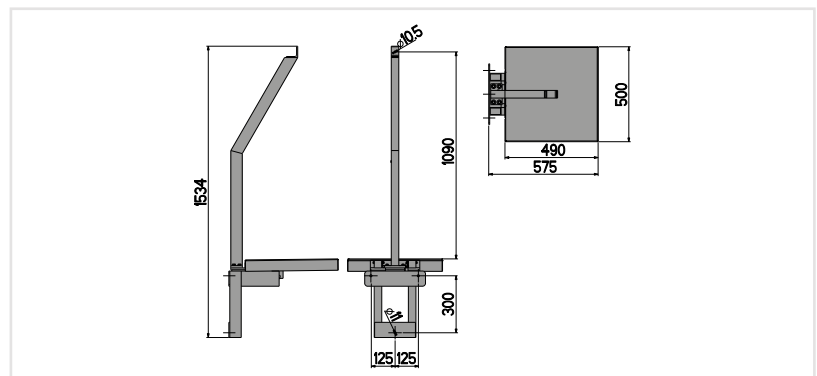
CAPACITY (kg)	LOAD PLATFORM (mm)	DIVISION (g)	
		STANDARD	APPROV*
150	490x500	50	50
300	490x500	100	100

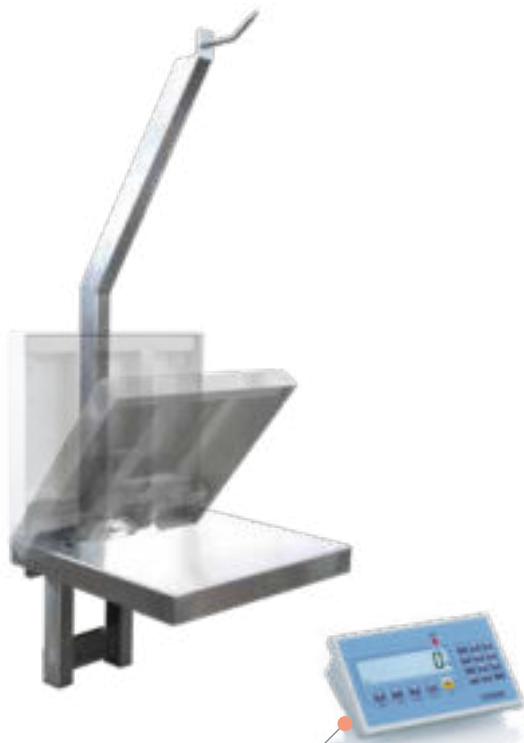

**CH. 2**

Go to chapter **FUNCTIONALITY** and choose **the indicator** most suited to your needs!

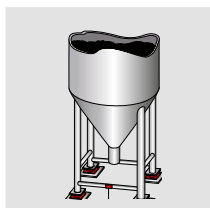

## WEIGHING KITS

These weighing kits enable to turn any rigid structure into an accurate and high-performing weighing system. Each model is especially designed to meet any precise requirements: weighing of tanks, silos and hoppers as well as of belts and roller conveyors, platforms and also suspended loads such as: big bags, beams or section bars, etc.



### Kit for high-load capacity systems (silos, hoppers, tanks, cisterns)

Compression load cells and assembly kit composed of watertight stainless steel accessories easy-to-install under the structure being weighed.

CAPACITY (kg)	SIZE (mm)
250, 500, 1000, 2500, 5000, 7500, 10.000, 15.000	175x150xh96
30.000	230x200xh118
50.000, 100.000	320x320xh154

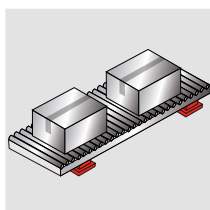

### Kit for medium-load capacity systems (silos, hoppers, tanks, cisterns, belts, platforms)

STAINLESS steel shear beam load cells and assembly kit made of galvanised steel easy-to-install directly under the structure being weighed.

CAPACITY (kg)	SIZE (mm)
300, 500, 1.000, 2.000	180x120xh110
3.000, 5.000	215x120xh150

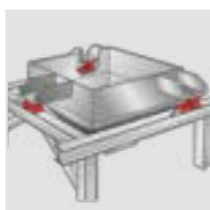

### Kit for low-load capacity system (fillers, hoppers, tanks, cisterns, big bags, screw batchers)

Bending beam load cells and assembly kit in STAINLESS steel easy-to-install directly under the structure being weighed.

CAPACITY (kg)	SIZE (mm)
10, 20, 50, 100, 200, 300, 500	135x70xh86

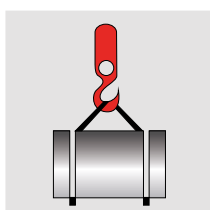

### Kit for suspended loads (big bags, hoppers, tanks)

Tension load cells and swivel eyebolts easy-to-install on lifting systems.

CAPACITY (kg)	SIZE (mm)
10, 20, 50, 100, 200, 300, 500	135x70xh86



AVAILABLE IN FINISHING



**CAP 2** Go to chapter FUNCTIONALITY  
And choose **the indicator**  
most suited to your needs!

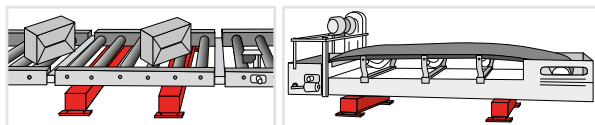

## Weighing bars

Pair of weighing bars to be installed under any structure being weighed. A sturdy and versatile solution for hoppers, belt and roller conveyors. A large fixing surface allows an easy and immediate assembly of the structure being weighed.

CAPACITY (kg)	SIZE (mm)				DIVISION (g)		
	2 x (400x80xh105)	2 x (600x105xh130)	2 x (800x135xh130)	2 x (1200x150xh120)	STANDARD	APPROV* €€ M	HIGH RESOL.
15	•				2	5	1
30	•				5	10	2
60	•	•			10	20	5
150	•	•	•		20	50	10
300		•	•		50	100	20
600			•	•	100	200	50
1500				•	200	500	100
3000				•	500	1000	200
6000				•	1000	2000	500

## Continuous weighing kit for belt conveyors

This kit allows to integrate a weighing area directly into the structure of the already existing conveyor belt for a real-time measuring of the quantity of material conveyed, hourly flow rate and total weight.

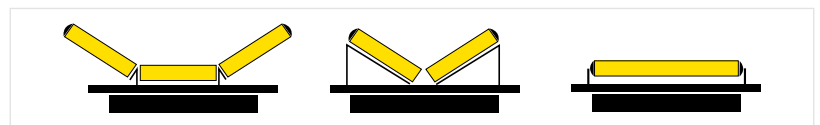

The kit can be used with any kind of idle roller.

BELT WIDTH (mm)	HOURLY FLOW RATE
400	from 10 kg/h to 70 t/h
500	from 10 kg/h to 80 t/h
650	from 10 kg/h to 90 t/h
800	from 10 kg/h to 100 t/h
1000	from 10 kg/h to 120 t/h
1200	from 10 kg/h to 150 t/h

**CAP 2** Go to chapter FUNCTIONALITY  
And choose **the indicator**  
most suited to your needs!





The basic model consists of two portable platforms and the weighing electronics in a practical case.

## Static and dynamic axle weighers

These axle weighers are ideal for use in all those applications requiring a quick and easy weighing of on-road vehicles such as: vans, lorries, tank trucks, transporters, tractors, waggons, etc. Especially suitable for a mobile and temporary use; their light weight, easy transport and placing allow to create in a very short time a weighing station on any kind of flat surface with a considerable time-money saving.

MAX. CAPACITY PER AXLE (kg)	SIZES (mm)				DIVISION (kg)		
	2 x (500x400)	2 x (700x450)	2 x (900x500)	2 x (900x700)	STANDARD	APPROV* CE M	HIGH RESOL.
3000	•				1	1	0,1
6000	•				2	2	0,2
12000	•	•	•		4	4	0,4
20000	•	•	•	•	10	10	1
25000	•	•			-	10	-
30000	•	•	•	•	10	10	1
40000			•	•	20	20	2
50000				•	20	-	2



## Multiplatform wheel scales

These wheel weighing platforms allow to weigh the whole vehicle in a single operation with high accuracy approved for legal-for-trade use. The wheel weighing system consists of a number of platforms corresponding to the number of wheels of the vehicle being weighed and is equipped with a fixed or portable indicator displaying the weight of any wheel, axle, total weight and barycentre coordinates. This wheel weighing system offers a considerable space-time saving and is ideal for a fixed as well as mobile or seasonal use.



PLATFORM SIZES (EACH) (mm)	MAX. CAPACITY VEHICLES A			
	2 AXLES (4 platforms)	3 AXLES (6 platforms)	4 AXLES (8 platforms)	5 AXLES (10 platforms)
400x300	2,4t, 6t, 12t, 24t, 32t	3,6t, 9t, 18t, 36t, 48t	4,8t, 12t, 24t, 48t, 64t	6t, 15t, 30t, 60t, 80t
500x400	6t, 12t, 24t, 40t, 50t, 60t	9t, 18t, 36t, 60t, 75t, 90t	12t, 24t, 48t, 80t, 100t, 120t	15t, 30t, 60t, 100t, 125t, 150t
700x450	24t, 40t, 50t, 60t	36t, 60t, 75t, 90t	48t, 80t, 100t, 120t	60t, 100t, 125t, 150t
900x500	24t, 40t, 60t, 80t	36t, 60t, 90t, 120t	48t, 80t, 120t, 160t	60t, 100t, 150t, 200t
900x700	40t, 60t, 80t, 100t	60t, 90t, 120t, 150t	80t, 120t, 160t, 200t	100t, 150t, 200t, 250t



## Electronic modular weighbridge

This weighbridge is a valuable product able to combine high loading capacity and high-accuracy weighing, keeping them intact and unchanged for many years to come.

All wearing parts are oversized and made of quality materials thus ensuring the highest performance under harsh working conditions. The weighbridge is capable of taking on a daily weighing of dozens laden vehicles for the whole year, trouble-free.

As standard it also offers an automatic double division of the reading, which allows for a more accurate weighing of contained loads while keeping unchanged the high loading capacity.

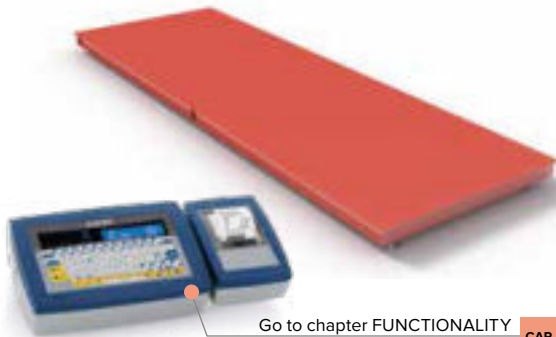

Go to chapter **FUNCTIONALITY**  
And choose **the indicator**  
most suited to your needs!

**CAP 2**



MAX. CAPACITY (kg)	SIZE (m)	DIVISION (kg)	
		APPROV*	€
30000/50000	9x3xh0.37	10/20	
30000/60000	13.5x3xh0.37	10/20	
30000/60000	18x3xh0.37	10/20	

## A new concept of weighbridge

This cutting-edge weighbridge is easy to install and does not require any special lifting equipment or masonry works which can perennially take up space on the courtyard.

Compared to standard models, this weighbridge has an important advantage: it can be moved from the area of use in order to create a new weighing station elsewhere or also be removed (seasonal use).

This feature is especially appreciated in building, in port areas, in farming.

**DUALTRACK**

JUST ONLY  
22 cm  
HIGH



Go to chapter **FUNCTIONALITY**  
And choose **the indicator**  
most suited to your needs!

**CAP 2**

CAPACITY (kg)	SIZE (m)					DIVISION (kg)	
	2 x (4.5x1xh0.22)	2 x (9x1xh0.22)	2 x (13.5x1xh0.22)	2 x (18x1xh0.22)	2 x (22.5x1xh0.22)	APPROV*	€
15000	•					5	
30000	•	•	•			10	
60000		•	•	•		20	
80000				•	•	50	

€ \*On request, depending on the model: multi scale: 3000+3000e





## Multifunction pallet truck weigher

Easy-to-use and handy pallet truck scale with weight indicator integrated into a rugged steel enclosure protecting the weighing electronics against accidental impacts.

Powered through 4 AA batteries and equipped with an optional park brake, it can be also used on board of vehicles.

CAPACITY (kg)	FORK SIZES (mm)	DIVISION (kg)
		STANDARD
2000	1150x550xh85	1



AVAILABLE IN FINISHING



STAINLESS



## Pallet truck with printer and rechargeable battery

Pallet truck scale fitted with function digital keyboard and printer, suitable for weighing and printing receipts and total weight.

Available in the version with large forks for “fruits & vegetables” and in a fully AISI 304 STAINLESS steel version.

CAPACITY (kg)	FORK SIZES (mm)		DIVISION (kg)	
	1150x550xh85	1150x680xh85	STANDARD	APPROV* CE M
	500/1000/2000	•	•	0,2/0,5/1
1000/2000	•	•	-	0,5/1



RADIO (868 MHz)



REVOLVING HEAD



## Professional high-precision pallet truck scale

Pallet truck scale equipped with a special mechanical system allowing a higher accurate weighing and a greater load capacity.

CAPACITY (kg)	FORK SIZES (mm)	DIVISION (kg)		
		STANDARD	APPROV* CE M	HIGH RESOL.
600/1500/2500	1150x550xh85	0,2/0,5/1	-	0,1/0,2/0,5
600/1500	1150x550xh85	-	0,2/0,5	-
1500/2500	1150x550xh85	-	0,5/1	-

Find out more on [www.diniargeo.com](http://www.diniargeo.com)

### Pallet truck with advanced data management

“Enterprise” is a high-order pallet truck scale using the latest technology to integrate and manage the weight data.

An advanced weighing program and a wide range of interfaces available allow it to be easily integrated into the corporate's IT network for a real-time data communication, issuing fully customised receipts or printing barcode labels. It can also be fitted with a barcode reader for a quick identification of the weighed product.

CAPACITY (kg)	FORK SIZES (mm)	DIVISION (kg)	
		STANDARD	APPROV* $\text{CE}$ $\text{M}$
500/1000/2000	1150x550xh85	0,2/0,5/1	-
1000/2000	1150x550xh85	-	0,5/1



### STAINLESS steel professional pallet truck scale

AISI 304 stainless steel professional pallet truck scale ideal for use in industrial environments where strict hygiene requirements must be met, suitable for the chemical and pharmaceutical industry and harsh working conditions. The weighing electronics are watertight with IP68 degree of protection.

CAPACITY (kg)	FORK SIZES (mm)	DIVISION (kg)	
		STANDARD	APPROV* $\text{CE}$ $\text{M}$
500/1000/2000	1182x550xh80	0,2/0,5/1	-
1000/2000	1182x550xh80	-	0,5/1

\*On request: ATEX version and “Pharma” version with standard division = 0,1 kg



### Professional pallet truck scales for ATEX potentially explosive environments



Pallet truck scales suitable for use in areas classified as potentially explosive (zones 1 and 21 & 2 and 22). The weight detection, through four IP68 ATEX certified stainless steel load cells, guarantees the weighing highest accuracy under any working condition. A wide range of accessories allows to transfer weighing data from the dangerous zone to the PC or the printer installed in a safe area for a subsequent processing.

CAPACITY (kg)	FORK SIZES (mm)	DIVISION (kg)		
		STANDARD	APPROV* $\text{CE}$ $\text{M}$	HIGH RESOL.
500/1000/2000	1150x550xh85	0,2/0,5/1	-	0,1/0,2/0,5
1000/2000	1150x550xh85	-	0,5/1	-
600/1500/2500	1150x550xh85	0,2/0,5/1	-	0,1/0,2/0,5
600/1500	1150x550xh85	-	0,2/0,5	-
1500/2500	1150x550xh85	-	0,5/1	-



## Weighing forks for lift trucks

Pair of forks with in-built weighing for lift trucks, easy-to-use, sturdy and reliable. They can be quickly and easily installed in place of the original forks and allow a clear display of the loaded weight. Compatible with any lift truck equipped with a DIN 15173 – FEM-type fork-carrying plate, IIA or IIIA class (IIB optional).



CAPACITY (kg)	FORK SIZES (mm)		DIVISION (kg)	
	1160x146xh65	1160x190xh80	STANDARD	APPROV.
500/1000/2500	•		1/2/5	-
1000/2500	•		-	2/5
1000/2500/5000		•	2/5/10	-
2500/5000		•	-	5/10

	A	B	C	D	E	F	G	H	I	L	M
LTF 25	1162	146	1277	326	720	82	385	76	65	700	355
LTF 50	1160	194	1290	376	1000	100	477	76	80	930	405

Dimensions in mm



## INTEGRATED SOLUTIONS

**APPS for smartphones and tablets for weight management and data sharing**



### ESSENTIAL TO:

- Read tare, gross and net weight
- Run a simple or pre-set tare and store up to 5 known tares
- Save weighing, add up and display the total immediately
- Enter texts or codes to identify any weighing.
- Share stored data on-line and in real time.



**GET DINI ARGEO APPS NOW ON**





Find out more on [www.diniargeo.com](http://www.diniargeo.com)

## Weighing carriage for forklift truck

Weighing platform for forklifts equipped with fixing guide, in compliance with DIN15173 - FEM, II class, suitable for turning an ordinary lift truck into a mobile electronic scale. Extremely sturdy and precise, it is the best solution for weighing any kind of product on pallet.

CAPACITY (kg)	FORK SIZES (mm)	DIVISION (kg)	
		STANDARD	APPROV* CE M
600	910x407xh110	0,2	-
1500	910x407xh110	0,5	-
2500	910x407xh110	0,5	-
600/1500	910x407xh110	0,2/0,5	1/2
1500/2500	910x407xh110	-	2/5



**CAP 2** Go to chapter **FUNCTIONALITY** And choose **the indicator** most suited to your needs!

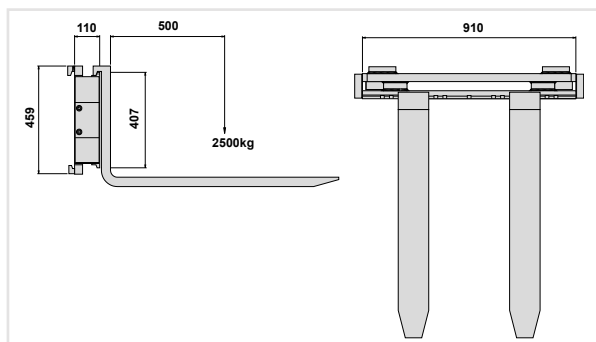

## The smartest and cheapest solution making your everyday work easier!

An application allowing for **real-time** weighing data sharing with the company IT system.



## Compact multifunction crane scales

Compact and versatile dynamometer fitted with protection transport case, remote control for teleoperation and batteries with 40h operating time. The weighing electronics are protected against shocks thanks to the body entirely made of painted steel and the backlit LCD display ensures high visibility under all conditions.

CAPACITY (kg)	SIZES (mm)			DIVISION (kg)	
	175x330	175x363	175x430	STANDARD	e $\leq$ $\frac{M}{M}$
300/600/1500	•			0,1/0,2/0,5	0,5
1500/3000/6000		•		0,5/1/2	2
3000/6000/9500			•	1/2/5	-
9000			•	-	5



## Professional STAINLESS steel crane scales

The best solution to weight suspended loads in industrial environments. The enclosure entirely made of AISI304 STAINLESS steel contains a rechargeable battery and a built-in load cell protecting them against shocks, dirty and rain. The high-brightness LED display is well visible from far-off distance and any direction.

CAPACITY (kg)	SIZES (mm)							DIVISION (kg)		
	290x382	270x440	270x451	270x592	270x640	270x730	270x850	STANDARD	e $\leq$ $\frac{M}{M}$	HIGH RESOL.
150	•							-	0,05	-
300	•							0,1	0,1	0,05
600	•							0,2	0,2	0,1
1500	•							0,5	0,5	0,2
3000		•						1	1	0,5
6000		•						-	2	-
6500		•						2	-	1
12000			•					5	-	2
17000				•				10	-	5
25000					•			10	-	5
30000						•		20	-	10
50000							•	20	-	10



## Professional reinforced crane scales

This dynamometer, resistant to any mechanical stress and sources of heat, is suitable for use in foundries and iron and steel industries. The special mechanical system allows a safe load handling in case of unfavourable weather conditions or accidental overloads. Powered by a rechargeable long operating-time battery. The compact sizes do not alter the load capacity of the lifting equipment. Equipped with high-brightness LED display, protected by a removable thick Plexiglass panel.

CAPACITY (kg)	SIZE (mm)	DIVISION (kg)	
		STANDARD	e $\leq$ $\frac{M}{M}$
10000	474x305	2	10
15000	474x305	2	10
25000	474x305	5	-
35000	474x305	10	-



Find out more on [www.diniargeo.com](http://www.diniargeo.com)

## ACCESSORIES FOR CRANE AND OVERHEAD CRANE SCALES

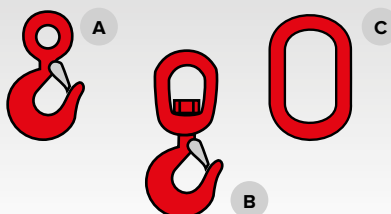

### Hooks and shackles

	CAPACITY (kg)
<b>A Fixed hooks</b>	1500, 7000, 15000, 22000, 30000
<b>B Swivel hooks</b>	10000, 15000, 25000
<b>C Shackles</b>	2000, 4000, 8000, 15000, 30000, 40000

Special hooks on request.



### Weight repeaters



A full range of weight repeaters available in wall, bench or portable versions, also fitted with a built-in printer, used to display the weight from far-off distance, to perform the functions of a dynamometer and to print receipts or labels or to save all working data on a USB flash drive. They are also useful for weighing bulky items, lifted-up and weighed through more crane scales.



### Calibration certificate

Each dynamometer can be supplied with a certificate of calibration performed in laboratory with deadweights that ensures the proper operation and expected performances. In addition, Dini Argeo offers a periodic maintenance service of the crane scale according to the safety standards in force.

A certificate of conformity to the European Machinery Directive, namely to the Directive 2006/42 EC, EN 13155 is also available on request.

**ScaleApp**

THE SMARTEST AND CHEAPEST  
SOLUTION MAKING YOUR  
EVERYDAY WORK EASIER!

### APPS for smartphones and tablets for weight management and data sharing



ESSENTIAL TO:

- Read tare, gross and net weight
- Run a simple or pre-set tare and store up to 5 known tares
- Save weighing, add up and display the total immediately
- Enter texts or codes to identify any weighing
- Share stored data on-line and in real time.

GET DINI ARGEO APPS NOW ON





INDUSTRY  
(ALL SECTORS)



COMMERCE  
AND DISTRIBUTION



AGRI-FOOD  
INDUSTRY



CHEMICAL-  
PHARMACEUTICAL  
INDUSTRY



TRANSPORT  
AND LOGISTICS



ELECTRONIC  
INDUSTRY



COMMERCE OF  
COMPONENTS AND  
SMALL PARTS



ENGINEERING  
INDUSTRY



## CHAPTER 2

### FUNCTIONALITY

# Many functions, added to weighing.

By virtue of a 100-year experience and with presence in more than 70 countries worldwide, Dini Argeo offers a full range of weight indicators with specific functions created starting from our customers' requirements, thus being able to meet every need, from a simple weighing to a customised application.

<b>MULTIFUNCTION AND SPECIFIC WEIGHT INDICATORS</b> , ideal for use in basic weighing applications	PAGE 34
<b>ADVANCED PROGRAMMABLE WEIGHT INDICATORS</b> , for customised weighing applications	PAGE 36
<b>ACCESSORIES</b> for weight indicators	PAGE 38
<b>WEIGHING SYSTEMS</b>	PAGE 40

Choose the indicator most suited to your weighing needs!

# MULTIFUNCTION AND SPECIFIC WEIGHT INDICATORS

## MULTIFUNCTION



### COMPACT

### LARGE DISPLAY

- Adjustable inclination
- **Easy-to-use**
- IP68 version
- Rechargeable battery

- **STAINLESS steel**
- **IP68 watertight**
- Function-numeric keypad
- ATEX/EX version

- **40 mm large display**
- **Colour backlight**
- STAINLESS steel enclosure
- Watertight (IP68)
- Rechargeable battery

- **40 mm superluminous RED LED DISPLAY**
- STAINLESS steel enclosure
- IP68 degree of protection
- **suitable for low-temperature environments**
- Rechargeable battery

## One indicator, many functions.



### MULTIFUNCTION WEIGHING program

Weight indicators of the multifunction range allow for quickly choosing the requested operating mode among those available. Any application mode offers functions and simple procedures to expedite and facilitate everyday work.

#### Horizontal totalisation

The function “totalisation” is useful for knowing the total weight of more consecutive weighings. For example it is suited to verify the load of a pallet before forwarding or the filling of tanks or the load of vehicles.

#### Formulation - Vertical totalisation

The “formulation” function simplifies the implementation of recipes or mixtures with known weights. Once the component is added, by pressing the dedicated key, the weight is summed up and reset. All components are then mixed and a summarising receipt can be edited at the end. The versions fitted with an enhanced keyboard can use digital IDs to identify the added product.

#### Pieces - quantity counting

The “pieces-counting” function is suitable for quickly knowing the quantity of pieces contained in a package, or for filling containers by picking up a certain number of pieces from the stock. The pieces-counting function allows for counting thousands of pieces quickly and accurately thus saving time and money.

#### Percent weighing

The “percent weighing” function is ideal when there is the need of creating mixtures with a variable total quantity, while keeping constant the percentage of each product. This function is very easy-to-use: set the total amount to be performed equal to 100.0%. The scale will show the percentage of the component in real time in order to amount to the correct percentages for each component. Percent checks can also be carried out by entering 100.0% as a reference value and verifying the deviation of successive weighings.

#### Weight checking

Weighchecking means to compare the weight of an object placed onto the scale with a pre-set reference value. Effectively, the reference weight can be quickly set by programming it through the keyboard, or putting it onto the pan and pressing the button concerned, and the tolerance range within which the verified weight shall be considered as compliant.

MODEL

FEATURES

FUNCTIONALITY ADDED TO WEIGHING

Find out more on [www.diniargeo.com](http://www.diniargeo.com)

FOR SPECIFIC APPLICATIONS



BATTERY AND PRINTER

- Attached printer protected from dust and moisture
- STAINLESS steel enclosure
- IP68 degree of protection for industrial use
- Rechargeable battery
- ATEX/EX versions
- Attached printer
- IP65 protection for industrial use
- Wide range of options
- Rechargeable battery



WHEEL AND AXLE WEIGHER

- Easy Axle program specific for axle and wheel weighing
- Rechargeable battery
- Transport protection case
- Integrated printer



WEIGHBRIDGE

- Easy Weighbridge program specific for weighbridge
- Rechargeable battery
- Attached thermal printer or
- Continuous-mode label printer



EASY AXLE Program

Program especially developed to easily weight any type of vehicles: axle weighing mode as well as wheel weighing mode.

- Single wheel load check
- Single axle load check
- Calculation of total weight
- Printing of any weight data, complete with barycentre coordinates, date and time and two freely programmable digital IDs.



EASY WEIGHBRIDGE Program

It includes all basic functions for managing a weighbridge and printing receipts:

- File archive up to 30 vehicle known weights (tares), quickly recallable, rapid weighing in a single operation
- Storage up to 99 input weighings and identification through automatic CODE
- Calculation of the net loaded/unloaded weight through difference between input and output weighing
- Input /output quick weighing
- Printing of input, output weights and difference
- Printing of a list of all partial weighings
- Printing of a single weighing ticket customisable with company name, weighing ID, date and time, etc.

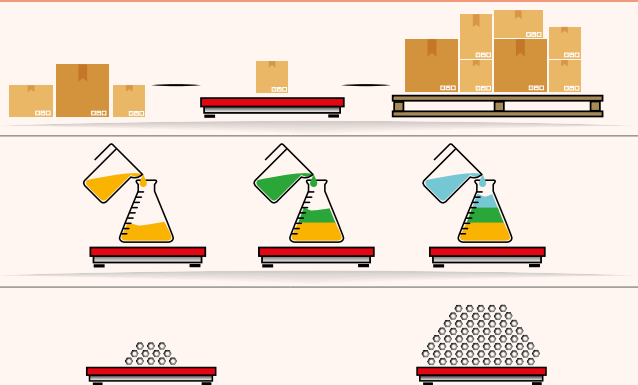

Reference carrying out to set the average unit weight.

Place on the platform the total quantity being counting.



WHEEL WEIGHER



AXLE WEIGHER

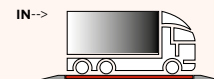

# PROGRAMMABLE WEIGHT INDICATORS

CH. 1 SCALES

CH. 2 FUNCTIONALITY

MULTIFUNCTION AND SPECIFIC INDICATORS

PROGRAMMABLE INDICATORS

ACCESSORIES

SYSTEMS

CH. 3 SOFTWARE

MODEL



## BATTERY AND PRINTER

- ABS IP65 enclosure
- Rechargeable battery
- **Compact and versatile, ideal for use in any sector and application**



- STAINLESS steel enclosure IP68 watertight
- IP65 integrated printer
- Rechargeable battery
- **Suitable for agri-food, chemical and pharmaceutical industries**



## LARGE DISPLAY

- **40 mm RGB large display, selectable colour (red, yellow, white, blue, purple, orange, green)**
- Adjustable intensity, designed for a clear reading at near or far distance



## TOUCHSCREEN

- **Colour backlit touchscreen display.**
- **Very quick and easy-to-use**
- STAINLESS steel enclosure IP68 watertight
- Suitable for use in agri-food, chemical and pharmaceutical industry and industrial applications in general
- **integrated superluminous semaphore for a rapid weighing check**

OUTSTANDING FEATURES

## A lot of programs at choice and countless customisations.

Over the years Dini Argeo has developed a series of weighing programs for its advanced indicators which can be perfectly keyed to the applications being performed. These programs include all the most advanced functions as to weighing and automated data management. The programs can also be completely custom-made.

- ✓ TECHNOLOGICALLY ADVANCED INDICATORS
- ✓ DESIGN AND STURDINESS
- ✓ VERY HIGH ACCURACY
- ✓ CUSTOM-MADE PROGRAMS



Find out more on [www.diniargeo.com](http://www.diniargeo.com) 



### FOR AUTOMATION

- STAINLESS steel enclosure IP68 watertight
- **Adjustable inclination bracket as standard**
- Integrated 3-colour semaphore for weight checks
- **Panel-mounting, it can be easily integrated into existing industrial automation**
- Digital inputs and outputs as standard

### PORTABLE

- **Rack version indicator, fitted with handy case and protection for portable weighing systems**
- Integrated printer
- Long-life battery

### BOX FOR OUTDOOR USE

- AISI 304 STAINLESS steel box fitted with weight indicator and in-built ACCESSORIES, suitable for outdoor installation in harsh industrial environments
- The inner space allows the installation of electrical components such as: relays, remote control switches, etc.
- Also suitable for weighbridges and self-service applications

## FIND OUT SOME OF THE MOST REQUESTED PROGRAMS:



Weight/Price/Amount and industrial labelling

 **PAGE 40**  
APPLICATION EXAMPLE



Quantity and piece counting multiscale with bar code printing

 **PAGE 42**  
APPLICATION EXAMPLE



Input/Output and complete management of weighbridges

 **PAGE 44**  
APPLICATION EXAMPLE



Static check of pre-packaged products

 **PAGE 46**  
APPLICATION EXAMPLE



Collection and advanced data management, totalisation and label printing

 **PAGE 48**  
APPLICATION EXAMPLE



Manual driven batching with correction / Tintometer / Formulation

 **PAGE 50**  
APPLICATION EXAMPLE



Vehicle weight and barycentre check, wheel and axles weighing

 **PAGE 52**  
APPLICATION EXAMPLE



Vehicle dynamic weighing

 **PAGE 54**  
APPLICATION EXAMPLE

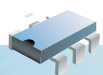

## ASK FOR A CUSTOM-MADE PROGRAM

Dini Argeo offers its customers complete customised programs according to the requirements and many custom-made solutions which are perfectly compatible with any existing systems.

## COMMUNICATION INTERFACES, PRINTERS AND ACCESSORIES for weight indicators

The functionality of weight indicators can be strengthened through a full range of available ACCESSORIES.

### DATA TRANSFER TO PC AND PORTABLE DEVICES

A wide range of communication interfaces between scale and company's computer system, necessary for real-time sharing of file archives and weighing data

In addition, they allow to use the SPECIFIC INDICATORS APPs in tablets and smartphones.



WI FI



BLUETOOTH

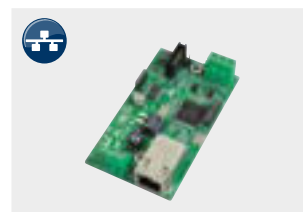

ETHERNET



RADIOFREQUENCY VIA USB OR RS232



USB



ANALOG OUTPUT



RS232 / RS485 / RS422



ETHERNET / MODBUS/PROFIBUS



OPTICAL FIBRE FOR COMMUNICATION IN ATEX AREA

### WEIGHT REPEATERS

They repeat the scale weight or data also at far distances, indoors as well as outdoors. The connection can be via cable or radio.



For advanced applications, multiple repeaters can be network connected





## PRINTERS AND LABELLERS

Impact, dot-matrix or thermal printers for printing of receipts and reports on thermal paper roll, continuous form or card. Direct thermal or heat-transfer labellers for printing of labels up to 100x120mm with any type of bar code.



BUILT-IN PRINTERS



DIRECT THERMAL LABELLERS



HEAT-TRANSFER LABELLERS



DOT-MATRIX PRINTERS



IMPACT PRINTERS



THERMAL PRINTERS

CONFIGURABLE TICKETS



## WEIGHING STORING



USB FLASH DRIVE

The USB flash drive is useful to store all weighings carried out by the scale for a further processing and storage on PC. It can store months of continuous work without ever have to download the data to a PC.

**5.000.000 weighings!**

## ADDITIONAL ACCESSORIES



MULTIFUNCTION REMOTE CONTROL



BAR CODE READERS



TRICOLOUR SEMAPHORE



ALPHANUMERIC KEYPADS

# WEIGHING AND DATA TRANSFER

CH. 1 SCALES

CH. 2 FUNCTIONALITY

MULTIFUNCTION AND SPECIFIC INDICATORS

PROGRAMMABLE INDICATORS

ACCESSORIES

SYSTEMS

CH. 3 SOFTWARE





Find out more on [www.diniargeo.com](http://www.diniargeo.com)



SOFTWARE INFO  
page 56

### System for weighing totalisation applications, fitted with one scale or multi-balances, for the management of file archives, added-up totals and configurable printouts.

This system can be paired to one or more bench and floor scales thus creating a weighing station and data management capable of storing any operation carried out, adding-up more weighings by calculating the total, printing receipts and labels with any kind of barcode and transferring all reports to the PC via Ethernet or WiFi.

#### FEATURES AND MAIN FUNCTIONS:

- Multi-balance manual or automatic totalisation
- Labelling, printing of receipts and packing list
- 4 stand-alone totalisation levels, updated at any weighing (usable for example as total of carton, pallet, shift and total per item)
- Print list of the last 1000 weighings
- File archives: 1000 items, 200 customers, 300 tares, expandable
- 15 texts freely programmable by operator (batch, code operator, shift, etc)
- Connectable up to five independent scales
- Alibi Memory protocol for applications legal-for-trade through PC
- Rapid selection of an item through barcodes reading.



#### RECEIPTS AND LABELS EXAMPLES

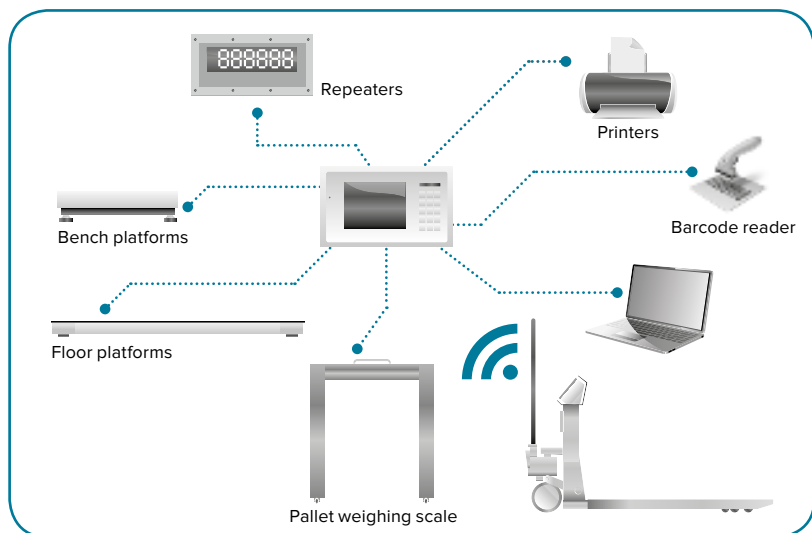

CUSTOMISABLE

Thanks to a large TOUCHSCREEN DISPLAY everything is under control



# WEIGHING AND COUNTING

CH. 1 SCALES

CH. 2 FUNCTIONALITY

MULTIFUNCTION AND SPECIFIC INDICATORS

PROGRAMMABLE INDICATORS

ACCESSORIES

SYSTEMS

CH. 3 SOFTWARE



Find out more on [www.diniargo.com](http://www.diniargo.com)



SOFTWARE INFO  
page 56

### System for piece-counting applications with totalisation and labelling functions.

Piece-counting system designed for counting applications and warehouse management, required for packaging of small parts, inventories and stocks tracking. High accuracy and counting resolution and online items storing, each with average unit weight, pre-tare and quantity control thresholds.

#### FEATURES AND MAIN FUNCTIONS:

- Multiscale quantity counting functions (pieces, liters, Newton, meters, etc.), during loading and unloading
- Rapid input of the reference quantity/Average Unit Weight /Conversion coefficient
- Counting automatic optimisation
- Weight and quantity totalisation
- Dosage in pieces, in loading or unloading
- 4 totalisation levels, stand-alone
- File archives: 1000 items, 200 customers, 300 tares, expandable
- 15 texts freely programmable by the operator (batch, code operator, shift, etc.)
- Automatic selection of the item through barcodes reading.



#### RECEIPTS AND LABELS EXAMPLES

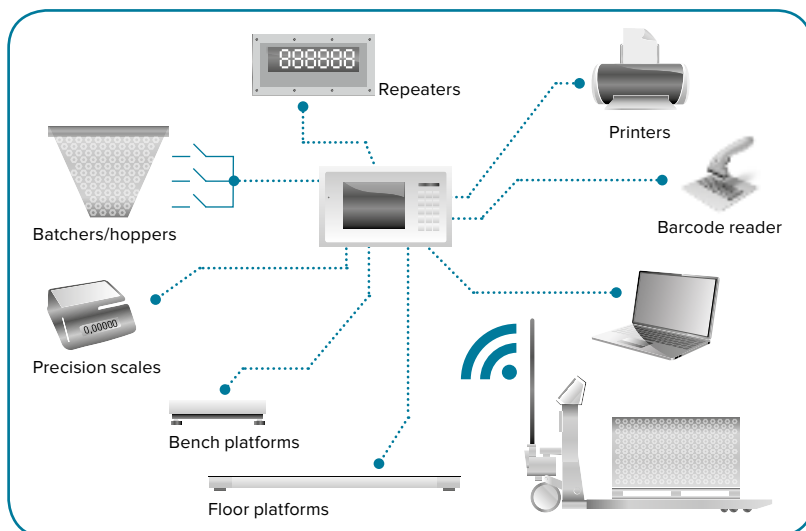

**CUSTOMISABLE**

Easy-to-use and rapidity thanks to the large **TOUCHSCREEN DISPLAY**



# VEHICLE WEIGHING AND MANAGEMENT

CH. 1 SCALES

CH. 2 FUNCTIONALITY

MULTIFUNCTION AND SPECIFIC INDICATORS

PROGRAMMABLE INDICATORS

ACCESSORIES

SYSTEMS

CH. 3 SOFTWARE





### System for weighbridge management with checking function of input/output goods and updating of file archives simultaneously.

Modular solution for a complete management of one or more weighbridges, with receipts, labels or notes on continuous form printing. The input/output function allows to monitor the quantity of unloaded and loaded material and to share data with the company's information system.

#### FEATURES AND MAIN FUNCTIONS:

- Weighing of a vehicle with or without trailer
- Operator-assisted or self-service weighing
- Input /output weighing storing through ID code or TARGA (999 open weighings)
- Connectable to two independent scales, with possibility of input/output weighing on the first or second scale
- Function A + B for scale 1, 2 or totalisation displaying
- Management of vehicles with trailer also on 2 scales
- Management of ANALOG or DIGITAL load cells
- File archives: 15 ID texts, 500 customers, 500 products, 500 vehicles, expandable.



#### RECEIPTS AND LABELS EXAMPLES

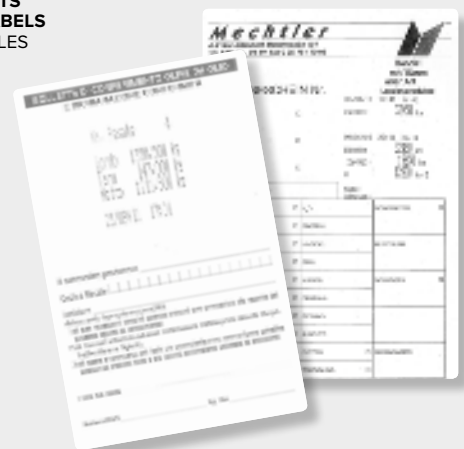

**CUSTOMISABLE**

Everything is just a click away, thanks to the **TOUCHSCREEN DISPLAY**

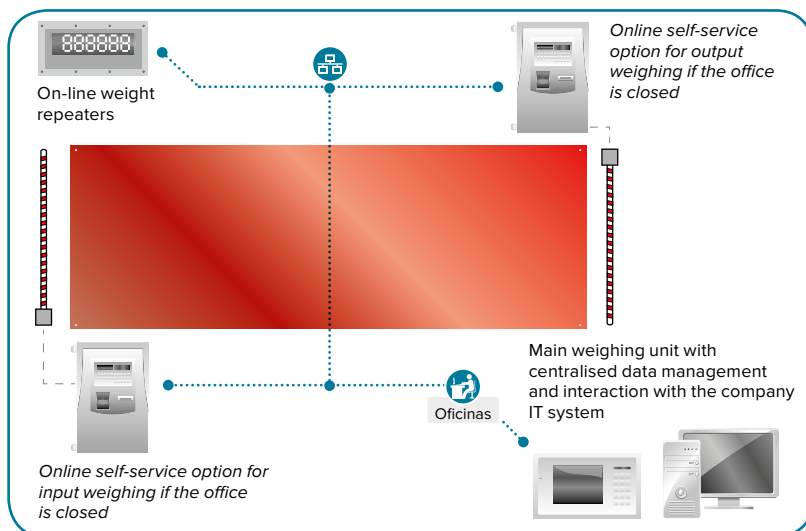
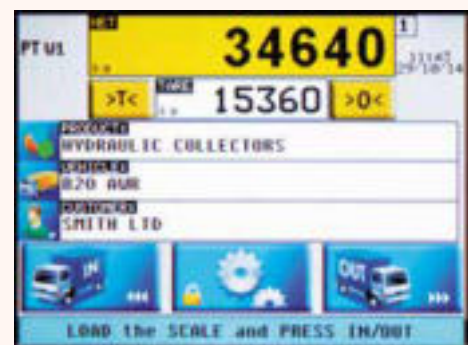

# WEIGHING AND QUANTITY CHECK OF PRE-PACKAGED PRODUCTS

CH. 1 SCALES

CH. 2 FUNCTIONALITY

MULTIFUNCTION  
AND SPECIFIC INDICATORS

PROGRAMMABLE  
INDICATORS

ACCESSORIES

SYSTEMS

CH. 3 SOFTWARE





Find out more on [www.diniargo.com](http://www.diniargo.com)

SOFTWARE INFO  
page 56



### System for advanced statistical checking applications as to pre-packaged products as provided for by Directive No.76/211/EEC.

Modular solution with one balance or multiscales offering the advantage of checking prepackaged products having a different weight by using the same system. The weighing program has been developed so as to perform all major statistical or integral checks as requested by the regulations in force, or can be customised according to specific needs, also for internal use.

#### FEATURES AND MAIN FUNCTIONS:

- Statistical check functions, selectable as CUSTOMISED (for indoor use) or according to LAW (as provide for by Directive No. 76/211/EEC):
  - DESTRUCTIVE or NON DESTRUCTIVE examination
  - Criterion of acceptance/rejection of the batch under examinatio
  - Calculation and printing of the batch report and of the standard deviation
- Control of the quantity in ml by entering a density coefficient for each item
- Simultaneous management of up to 10 production lines
- File archives: 15 ID texts, 1000 items, expandable
- Connectable up to 4 stand-alone scales.



RECEIPTS AND LABELS EXAMPLES

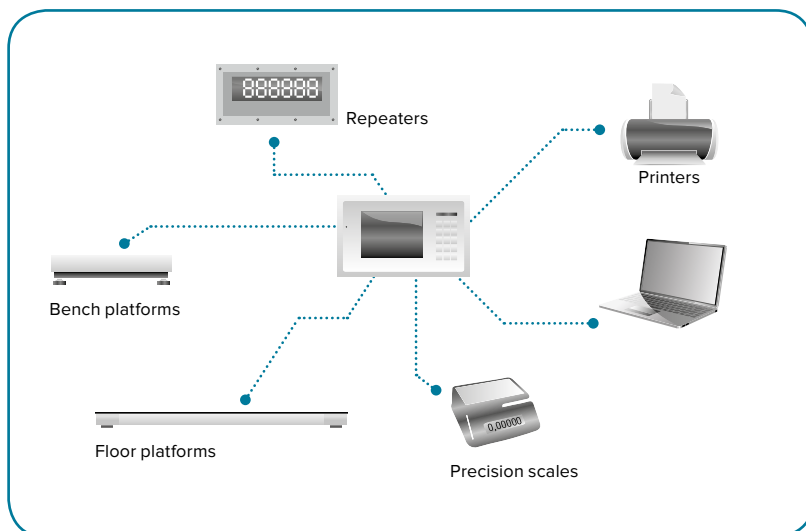

**CUSTOMISABLE**

Everything is just a click away, thanks to the **TOUCHSCREEN DISPLAY**

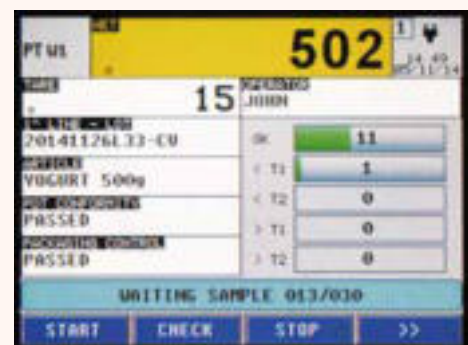

# WEIGHING, DATA MANAGEMENT AND LABEL PRINTING

CH. 1 SCALES

CH. 2 FUNCTIONALITY

MULTIFUNCTION AND SPECIFIC INDICATORS

PROGRAMMABLE INDICATORS

ACCESSORIES

SYSTEMS

CH. 3 SOFTWARE



Find out more on [www.diniargeo.com](http://www.diniargeo.com)

 SOFTWARE INFO  
page 56



## System with advanced weighing/pricing function, PLU management and item traceability.

This solution allows to manually label a lot of packages in a very short time, with indication of the ingredients, traceability, date of packaging, expiration date and any kind of barcode.

The system is able to print labels by means of ANY TYPE of ASCII LABELLER (Italora, Epson, Datamax, Zebra, Citizen, TSC, etc.) and can be adapted to the existing computer system.

### FEATURES AND MAIN FUNCTIONS:

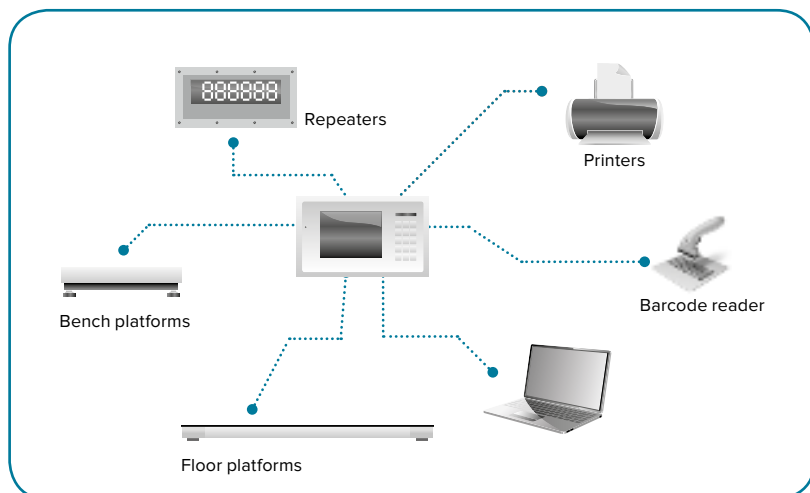
- Weighing /pricing functions:
  - Calculation and displaying of price and amount
  - Fixed or variable weight operation
  - Dual currency management with conversion factor
  - EAN product code management and checkdigit calculation
  - Product traceability
  - Ageing and expiration date management
  - Totalisation of weight and amount
- Up to 5 levels of independent totals
- File archives: 1000 items, 200 customers, 300 tares
- Connectable up to 4 stand-alone scales.



RECEIPTS AND LABELS EXAMPLES



CUSTOMISABLE

Everything is just a click away, thanks to the **TOUCHSCREEN DISPLAY**

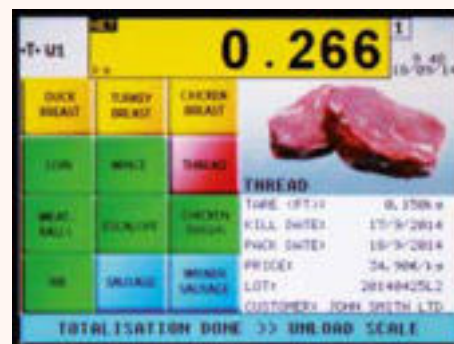

# WEIGHING AND MANUAL DRIVEN BATCHING

CH. 1 SCALES

CH. 2 FUNCTIONALITY

MULTIFUNCTION AND SPECIFIC INDICATORS

PROGRAMMABLE INDICATORS

ACCESSORIES

SYSTEMS

CH. 3 SOFTWARE



Find out more on [www.diniargeo.com](http://www.diniargeo.com)

SOFTWARE INFO  
page 56



## System for weighing and manual batching by formulas and guided correction function of a mixture in case of overdosing.

Solution especially designed to assist the operator in creating solid as well as liquid multi-component mixtures, thus reducing considerably errors and wastefulness, thanks to a clear on-screen messaging and to the correction function of the out-of-tolerance dosage.

### FEATURES AND MAIN FUNCTIONS:

- File archive: 500 recipes, expandable
- File archive: 200 components, each with free descriptions, target range and max admissible error
- From 1 to 20 components per formula
- File archive: 15 texts freely programmable by operator, such as: shift, batch, operator code, comment, etc.
- 3 different operating modes:
  - **FIXED TARGET:** the weights of each component are preset in the recipe
  - **PROGRAMMABLE TOTAL TARGET:** the percentage of each component is specified in the formula. Before starting batching, the operator sets the total amount to be weighed out. The balance recalculates the weight of each component automatically according to the pre-set percentage
  - **FIRST COMPONENT recalculation:** the percentage of each component is specified in the formula. The operator weighs out the requested quantity as to the **FIRST COMPONENT** and the balance calculates the weight of the components to be added according to the pre-set percentage
- Automatic wizard correction of any overdosing
- Optional management of stocks, with shortage alarm per component
- Multiscale weighing-out, with automatic scale change.



### RECEIPTS AND LABELS EXAMPLES

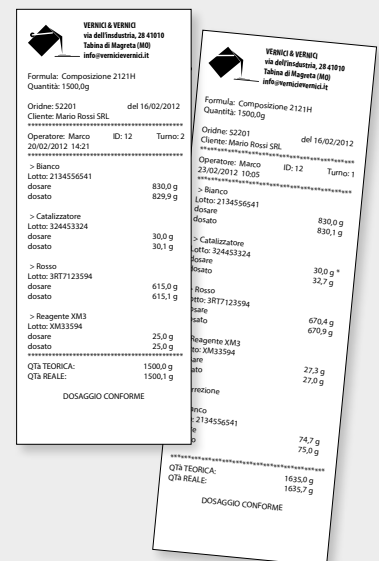

**CUSTOMISABLE**

Everything is just a click away, thanks to the **TOUCHSCREEN DISPLAY**

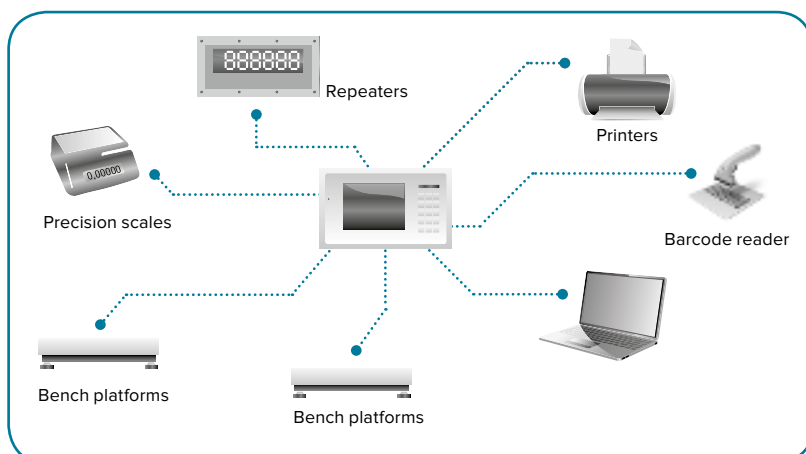
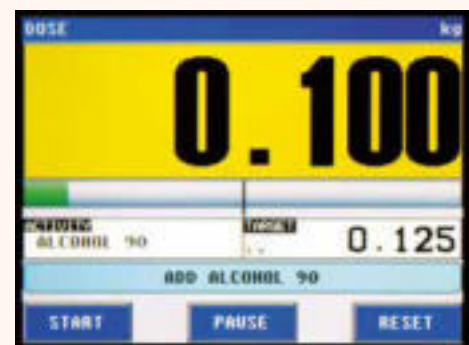

# VEHICLE WEIGHING AND BARYCENTRE CHECKING

CH. 1 SCALES

CH. 2 FUNCTIONALITY

MULTIFUNCTION  
AND SPECIFIC INDICATORS

PROGRAMMABLE  
INDICATORS

ACCESSORIES

SYSTEMS

CH. 3 SOFTWARE



## EXAMPLE OF WIRELESS OPTION



## Multi-platform system for vehicle weighing and checking, with calculation of the barycentre coordinates.

Modular portable solution, battery-operated, designed for the creation of wheel weighing stations, suitable for weighing any type of vehicle as well as objects with more support points.

The cased weight indicator is equipped with a printer printing weighing receipts including all vehicle weight data, the weight of any wheel, axle, vehicle total weight, gross, tare, net weight and barycentre.

### FEATURES AND MAIN FUNCTIONS:

- Multi-scale wheel weighing operating mode with 4 reading channels (for 4 independent platforms)
- Calculation of the barycentre coordinates of vehicles, trucks, aircrafts, containers, etc.
- Simultaneous display of the load of each wheel, axle and total weight
- Archives: 15 ID texts, 1000 memories for vehicle, customers, materials management
- Possibility of managing up to 16 platforms.

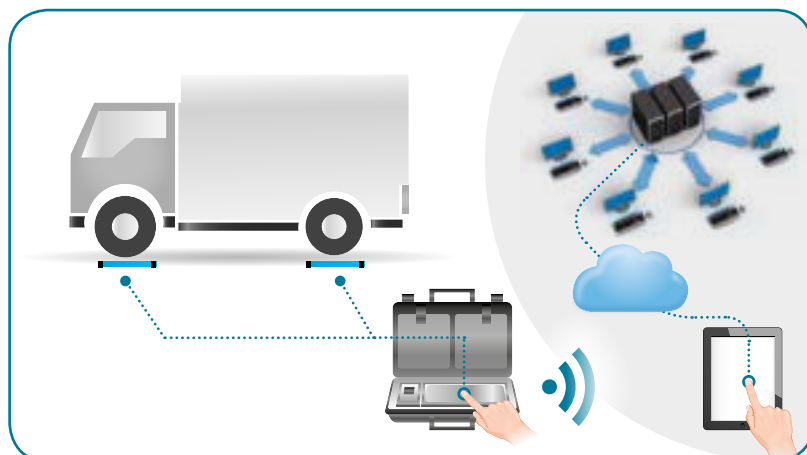

### RECEIPTS AND LABELS EXAMPLES

MARIO ROSSI	
VIA INDIPENDENZA 157 - MILANO	
RUOTA 1	5000kg
RUOTA 2	5000kg
ASSE 1	10000kg
RUOTA 3	5000kg
RUOTA 4	10000kg
ASSE 2	5000kg
RUOTA 5	5000kg
RUOTA 6	10000kg
ASSE 3	5000kg
RUOTA 7	5000kg
RUOTA 8	10000kg
ASSE 4	5000kg
RUOTA 9	5000kg
RUOTA 10	10000kg
ASSE 5	10000kg
TOTALE	50000kg
TARA	3500kg
NETTO	46500kg
SCARICO	22/12/2012 17:00
***** BUONA GIORNATA	



Easy-to-use and rapidity thanks to the large **TOUCHSCREEN DISPLAY**

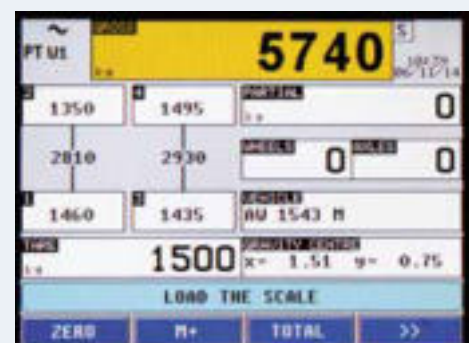

# VEHICLE DYNAMIC WEIGHING

CH. 1 SCALES

CH. 2 FUNCTIONALITY

MULTIFUNCTION  
AND SPECIFIC INDICATORS

PROGRAMMABLE  
INDICATORS

ACCESSORIES

SYSTEMS

CH. 3 SOFTWARE





Find out more on [www.diniargeo.com](http://www.diniargeo.com)

## System for static or dynamic weighing and totalisation of vehicle axle with goods input/output check.

Modular solution ideal for weighing each axle of a vehicle, both in static mode with stationary vehicle and in dynamic mode with vehicle in motion. The axle weighing also aims at detecting any possible overload on the axles thus avoiding penalties in case of controls. Thanks to the input/output function it is also possible to weigh the quantity of material unloaded or loaded and to transmit all data to the company's IT system.

### FEATURES AND MAIN FUNCTIONS:

- Manual axle weighing and totalisation
- Automatic static axle weighing and totalisation
- Dynamic axle weighing and totalisation
- Two operating modes are available:
  - Vehicle weight checking with printout of the axle weights and of the total weight
  - Axle totalisation with input/output function
- Storage of input /output weighings through ID code or TARE (999 open weighings)
- Up to 6 independent totalisation levels
- Archives: 15 ID texts, 500 customers, 500 products, 500 vehicles.

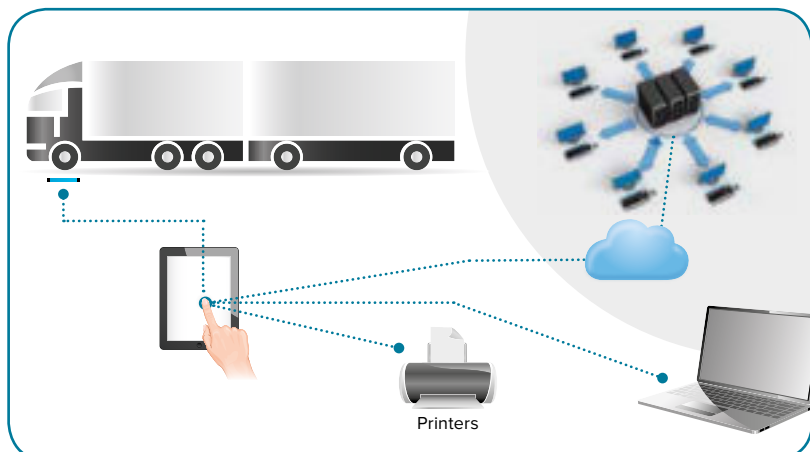

### RECEIPTS AND LABELS EXAMPLES

MARIO ROSSI SRL		MARIO ROSSI	
VIA INDEPENDENZA 157 - MILANO		RUOTA 1	5000kg
www.mario-rossi.it		RUOTA 2	10000kg
0039 - 0278223154		ASSE 1	5000kg
Cliente: BROWN LTD		RUOTA 3	5000kg
TARGA: AA000BC		RUOTA 4	10000kg
Materiale: ARGILLA		ASSE 2	5000kg
Operatore: ALESSIO		RUOTA 5	5000kg
ENTRATA PT		RUOTA 6	10000kg
		ASSE 3	5000kg
		RUOTA 7	5000kg
		RUOTA 8	10000kg
		ASSE 4	5000kg
		RUOTA 9	5000kg
		RUOTA 10	10000kg
		ASSE 5	
USCITA PT		TOTALE	50000kg
SCARICO		TARA	3500kg
***** BUONA GIORNATA		NETTO	46500kg
		22/12/2012	17.00



### DINI SMART AXLE

App for tablets and smartphones







## CHAPTER 3

### SOFTWARE

# A program for each weighing application.

In every company where weighing is the core of the business, the PC programs developed by Dini Argeo are essential for integrating the weighing system into the production process, real-time sharing of all weight data, with time-money saving and reducing operational errors considerably, through simple wizards and intuitive procedures, tailored to every requirement.

---

**SPECIFIC PROGRAMS** for weighing applications

PAGE 58

All the programs are available for traditional PC as well as for TOUCHSCREEN PC.



## Programs developed for simplifying weighing management...



### COUNTLESS ADVANTAGES:



Flexible and versatile installation: thanks to the configurable data interchange module, each program can interface with **any already installed management operating system** for stocks updating/stocks integrated management, downloading of production orders, forms, item database, customer database, etc.



Complete management of the orders placed by a customer, thanks to customisable wizards, enhanced by automatic or manual controls thus ensuring quality.



Dispatch of the order, by printing the transport document both on paper and electronic format, also with automatic transmission to the customer.



Fast and safe automatic updating of the management operating system, without any manual operation required.

# ... and data integration.



ALL THIS WILL RESULT IN:

**HARD AUTOMATION**  
of the production process thus  
minimising errors, wastefulness  
and implementation times.

**Easier integration of accessories** such as barcode readers, palmtops, smartphones, tablets and all the latest communication technologies, in order to be always at the forefront.

**Integration of weighing systems** in a same working area, or at different sites, locally, nationally or worldwide with centralization of the collected data.

**Rapid and safe management of large data flows:**  
It will no longer be required to input large amounts of data, since there is a real-time data interchange at any weighing and all information is available online, accessible from anywhere, also from web platforms.



## LABELLING, TRACEABILITY AND BATCH MANAGEMENT



Items, PLU, ingredients, clients uploading by management system

Driven-execution of the orders to be fulfilled

Packaging and labelling with all data and barcodes

Full traceability of the product as well as of the batch

Real-time issuance of documents

## PIECES COUNTING, ORDERS AND STOCKS MANAGEMENT

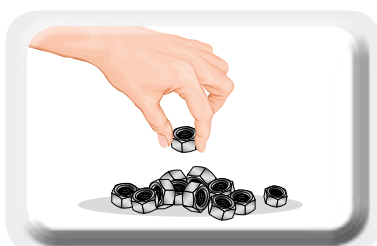

Driven-execution of the orders to be fulfilled

Counting, packaging and labelling

ODETTE-type labels of any format

QR Codes (Data Matrix)

Real-time issuance of documents

## MANUAL ASSISTED BATCHING, ERROR CORRECTION AND STOCKS CHECKING



Centralised formulation

Driven execution of formulas

Stock control and management with alarm in case of shortage

Assisted correction of overdosages to reduce material wastefulness

Real-time issuance of documents

## MULTI-STATION STATISTICAL CHECK FOR PRODUCTION LINES



Integral check of the batch

Statistical check according to the standard 690/78

Packaging quality control

Real-time monitoring of all production lines

Printing of any batch report and total report

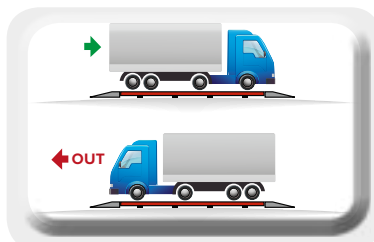
**GOODS LOADING/UNLOADING CHECK AND STOCKS UPDATING**

Monitoring of the input/output material flow

Stocks updating

Video surveillance of the weighbridge and all operations carried out, with automatic detection of the plate and images of the load and the weighed vehicle

Issuance of documents in real time, with fiscal memory of the performed operations

**WASTE SEPARATION AND DISPOSAL**

Archives shared management as to users, database, job-orders, types of waste containers, customers, departments, batches, labels or other customisable data according to client's requirements

Waste traceability

Management and printing of configurable batch covering labels, with the possibility of writing in logos, images, barcodes, etc.

**SUPERVISION OF WEIGHING SYSTEMS AND DATA COLLECTION**

Collection and recording of all weighings carried by each on-line weighing systems for further processing

Data format completely CUSTOMISED with addition of free texts written up by operations during weighing operations

**PRODUCTION CONTROL / QUALITY CONTROL / SORTING**

Specific program for weighing and control of products conveyed on production lines

In addition to checkweighing, the program asks the operator for a visual verification of all the control criteria requested, freely programmable (i.e. packaging integrity, viscosity, colour, etc.)

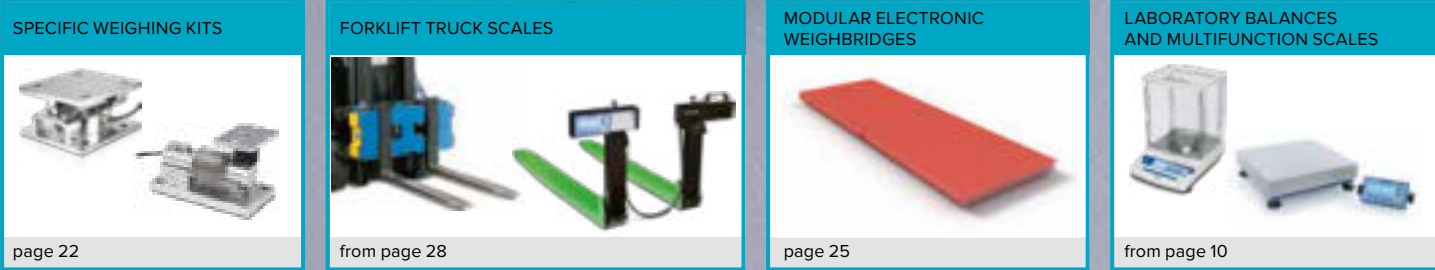
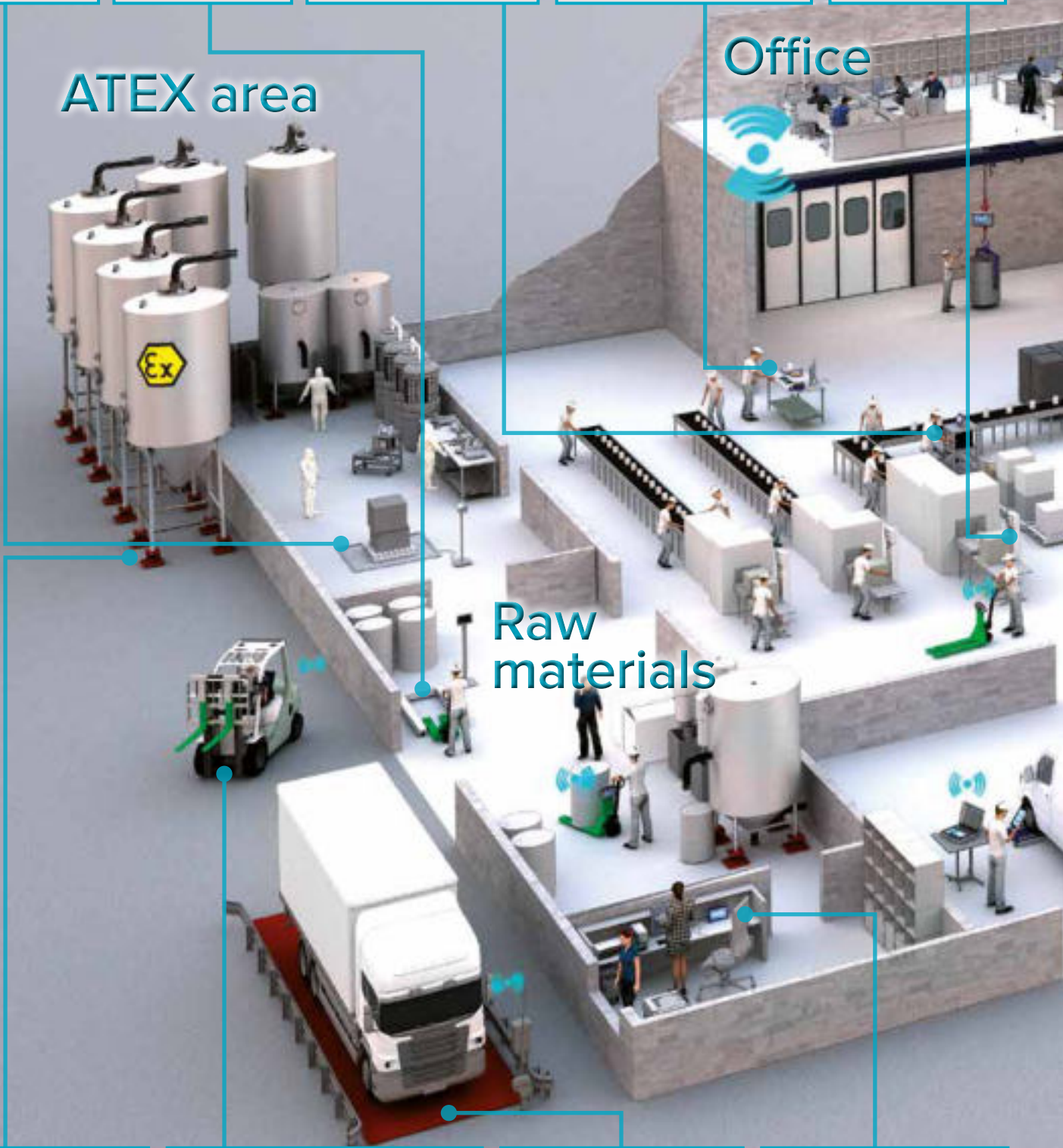
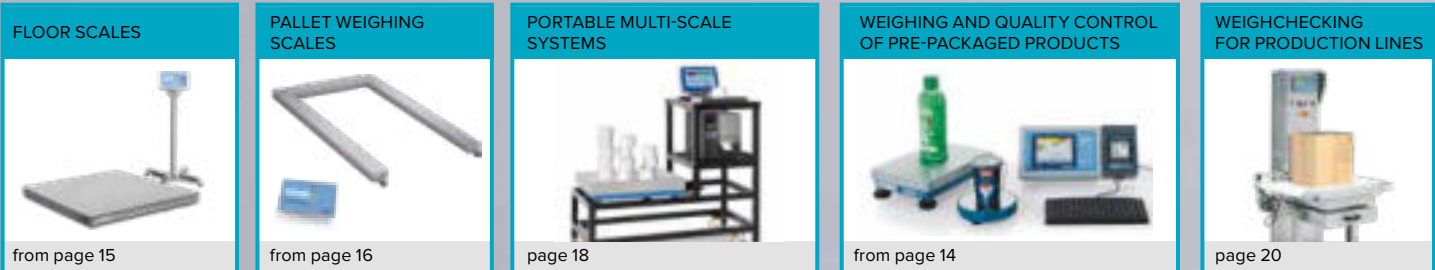



SOFTWARE AND INTEGRATED SOLUTIONS



from page 56

WEIGHT REPEATERS



page 31

CRANE SCALES



page 30

WEIGHING SYSTEM FOR BELT CONVEYORS

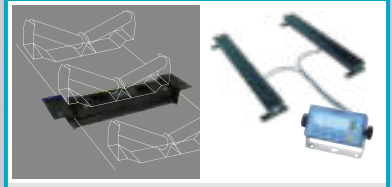

page 23

Warehouse area

Production area

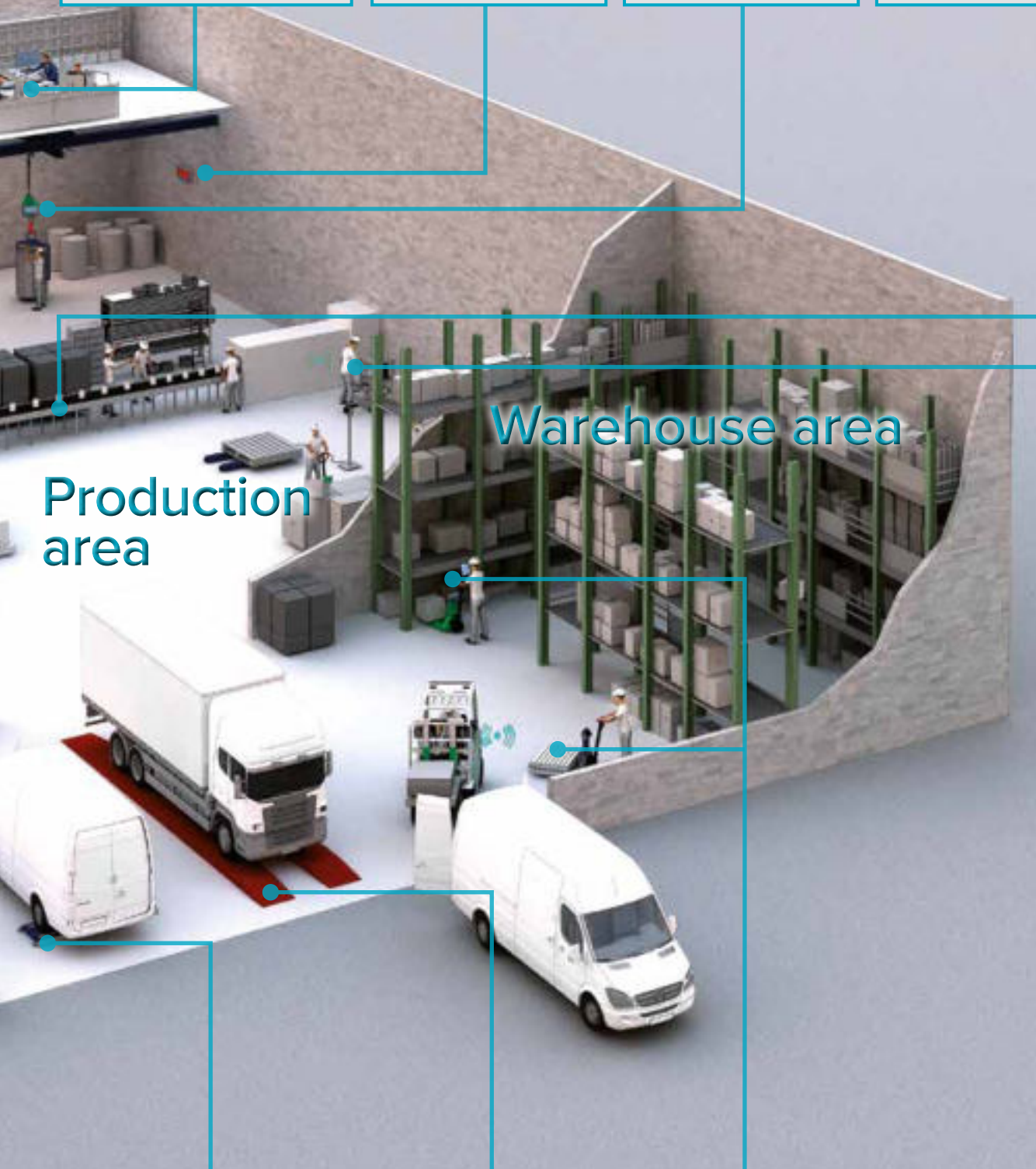

SCALES FOR VEHICLE CHECKING AND WEIGHING



page 24

REMOVABLE WEIGHBRIDGES



page 25

PALLET TRUCK SCALES



from page 26

WEIGHING, PIECE-COUNTING, TOTALISATION AND LABELING.



from page 14







“YOUR WORLDWIDE PARTNER FOR WEIGHING”

**DINI ARGEO**  
**FRANCE sarl**  
France

**DINI ARGEO**  
**GMBH**  
Germany

**DINI ARGEO**  
**UK Ltd**  
United Kingdom

**DINI ARGEO WEIGHING**  
**INSTRUMENTS Ltd**  
China

**DINI ARGEO**  
**WEIGHBRIDGES**  
Italy



A RICE LAKE WEIGHING SYSTEMS COMPANY

**OFICINA CENTRAL**

Via Della Fisica, 20  
41042 Spezzano di Fiorano Modena • Italy  
Tel. +39.0536 843418

**SERVICIO DE ASISTENCIA**

Via Dell'Elettronica, 15  
41042 Spezzano di Fiorano Modena • Italy  
Tel. +39.0536 921784

SALES AND TECHNICAL ASSISTANCE SERVICE