

# TESA MICRO-HITE

THE QUICK AND ACCURATE MEASUREMENT



# TOWARDS EXCELLENCE



The complexity of Modern Industry is increasingly diverse and understanding its needs is paramount to TESA.

Because your metrological concerns are also ours, we are constantly striving to develop solutions adjusted to your needs. Longevity, robustness and simplicity are the core of our passion and innovations are our total commitment to YOU.

The result?

Your satisfaction over the years.

Our pleasure?

To know that our products help you quickly and efficiently managing the constraints that emanate from your researches and developments.

**Uwe BURKARDT,**  
TESA Marketing Director

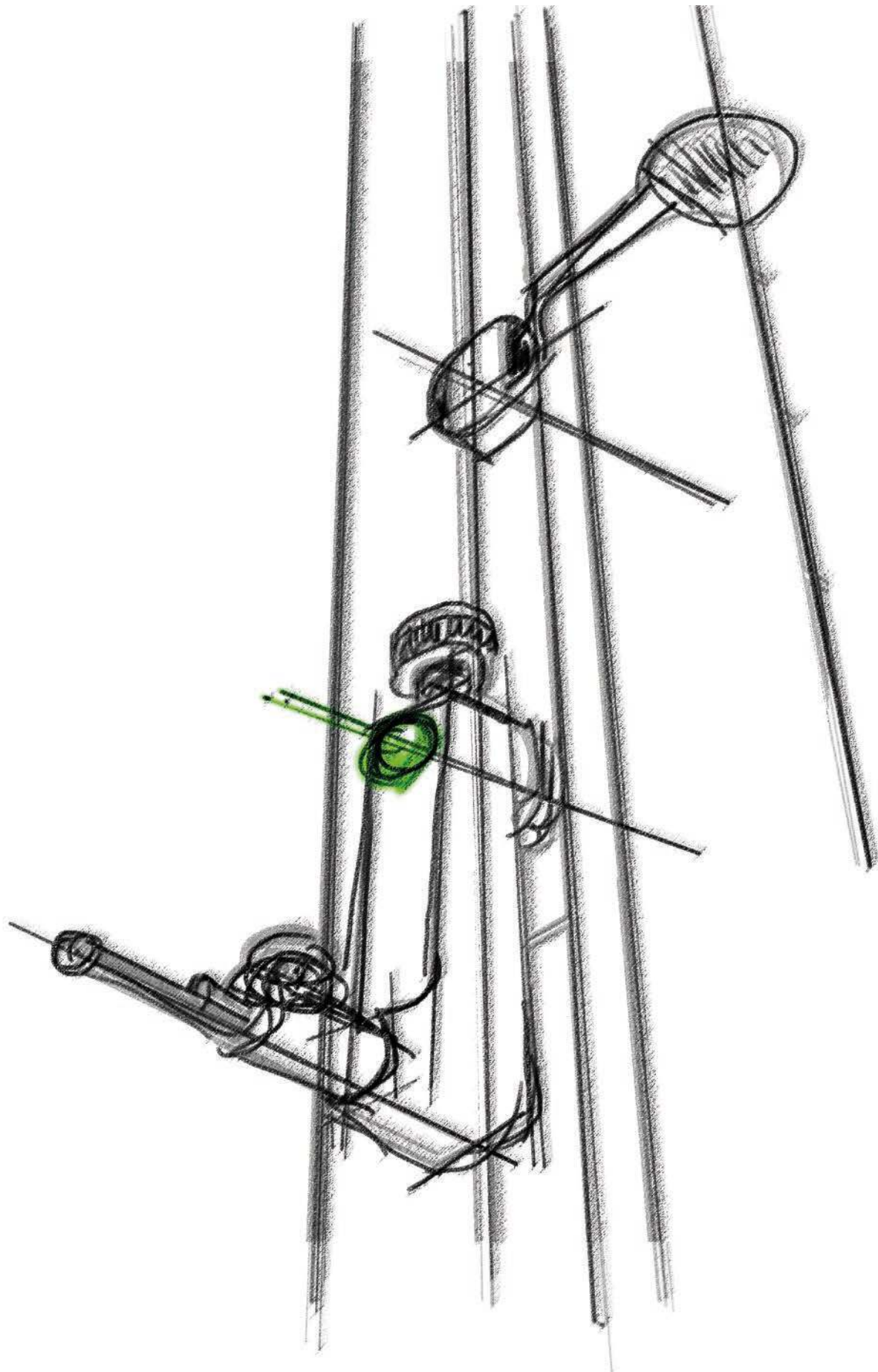

# ONE SOLUTION FOR EACH USE

The range of TESA height gauges consists in different models intended for monitoring operations during manufacturing or directly for a processing machine. These gauges allow a reliable measurement during the setting or sampling when the machining and the dimensions of parts turn out to be critical and need accurate and immediate control.



## TESA MICRO-HITE

These MANUAL gauges are universal workshop or laboratory machines which are reliable and robust to be integrated as close as possible to the user. Multifunctional but always simple to use, they are a metrological multi-user asset, that replaces the most conventional measuring tools.

**350 mm - 600 mm - 900 mm**

Embedded (patented) technologies



*opto p system*

## TESA MICRO-HITE+M

The MOTORIZATION of these height gauges makes them the most precise of the range. They distinguish themselves primarily by their exclusive and patented handwheel for displacement (FEEL&MOVE), combining fast probe positioning with fluidity during the execution of a measurement sequence.

**350 mm - 600 mm - 900 mm**

Embedded (patented) technologies



*opto p system*



# THE SECURITY OF A PRODUCT OF QUALITY

The TESA products are since their development phase submitted to strict internal standards, aligned with the most restrictive national standards. Thanks to this tight monitoring, all the TESA gauges satisfy the quality charter that we strive to maintain as demanding as possible.



## SCS certificate

Each gauge of the range is delivered with a SCS (Swiss Calibration Service) certificate of measurement.

 *Any hidden additional extra cost due to a re-certification of the instrument after purchase is avoided.*



## Calibration process

All the height gauges of the TESA range are calibrated and inspected in accordance with the standards described by the ISO 13225 standard. Each instrument is controlled and calibrated according to processes comparable to a real daily use.

 *The announced technical specifications are in agreement with a real use of the instrument.*



## A philosophy of use for everyone

With its refined user interface, ergonomic panel and context-based help, the MICRO-HITE range is designed to be accessible to any user profile.

 *Short learning time, user autonomy reached within 1 day maximum.*



## Clear information

No confusion! At any time, the displayed values correspond solely to a measurement or calculation and not to the instantaneous position of the probe.

 *Decrease of possible errors due to bad interpretations of the displayed results.*



## A robust construction

At the heart of each machine is a design utilizing the excellent microstructure properties of spherical cast-iron. All models incorporate industry accepted materials perfectly suited to the production of traditional components.

 *The components' stability provides reliability of the instrument in the long term.*



## A monobloc base

All the bases are machined from a single block of material.

 *1. Reduction of the thickness of the air cushion = decrease of the influence on the results  
2. Easy moving on a surface even with grooves or roughnesses*



## 4 years warranty

Our increasingly high quality standards allow us today to offer you four years of warranty. This allows you to concentrate on your expertise with peace of mind.

 *By registering your height gauge on [www.TESAtechnology.com](http://www.TESAtechnology.com), you benefit of 3 additional years of warranty.*



TESA reading system  
(patented)  
*opto u system*

Connector  
for accessories

Measuring help  
system (patented)  
**Quick center**

Spheroidal cast iron  
base & frame

Support faces

Adjustable  
panel arm  
(2 degrees of  
freedom)

Touch-  
screen

Refined-  
backlit  
keyboard

Ergonomic handling

Air cushion  
activation

Manual displacement  
wheel

Manual TESA MICRO-HITE

TESA reading system  
(patented)  
*opto $\mu$ system*

Handle for manual  
probe displacement

Connector  
for accessories

Measuring help  
system (patented)



Spheroidal cast iron  
base & frame

Support faces

Adjustable  
panel arm  
(2 degrees of  
freedom)

Touch-  
screen

Refined-  
backlit  
keyboard

Ergonomic handling

Air cushion  
activation

Intelligent handwheel for  
displacement





# Faster thanks to the QUICKCENTER technology

The QUICKCENTER technology has been specially integrated in order to clarify the information received during the measurement. It is mainly used to determine efficiently the culmination points (minimum, maximum, diameter).

No more endless measurements or hazardous results. With the QUICKCENTER technology, measuring bores/shafts becomes child's play.



1. Simplified measurement processes of culmination points reduce drastically the time required to measure a bore/axis
2. Visual information during the measurement in noisy environments



## A refined backlit keyboard

With a simplified panel containing a number of keys reduced to the strictly necessary, the handling is easy, fast and does not leave room for confusion.

The keyboard contains a backlight to improve the reading comfort at low-light areas in workshops.



### 1 key = 1 function

It is no longer necessary to spend long hours learning how to use the instrument. The management of the capacities of the gauge is intuitive which allows to avoid hidden costs during the setting-in.



## Hybrid panel

Each user has the possibility to choose between a 100% touch-use, via the control keyboard, or mixed. This makes the hybrid nature of this panel easy to use when navigating in the various menus as well as while managing measurement actions.



Comfortable and flexible use via the interaction of two navigation processes adapted to any type of environment of use.







## Ergonomics up to the fingertips

Comfort is definitely an important criterion for a regular daily use of an instrument.



*The handle has been specially studied to maximize the posture convenience while using the instrument.*



## Intelligent handwheel

Thanks to the FEEL&MOVE technology, the handling during a measurement with a lot of manipulations and precise movements of the instrument within small elements is comfortable.



1. Fast probe positioning
2. Fluid execution of measurements



## Modular rechargeable battery

The TESA height gauges are supplied with a rechargeable battery easily accessible and quickly removable from the device.



*The parallel use of a second battery thanks to an interchangeable system, allows to have an infinite operative instrument without having it connected to an electrical network.*



## Flexible support

In metrology, each need is different. The arm supporting the control panel allows an adaptable positioning to cover all the situations of use.



*Optimal reading of the screen at any time.*

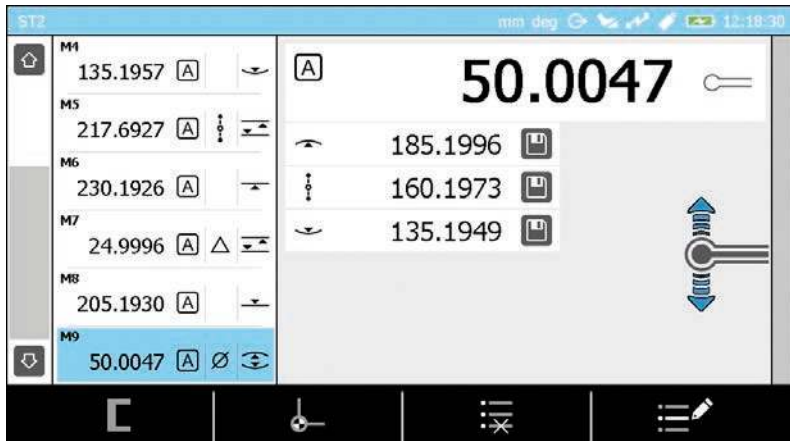

## Clear interface

Reading information is facilitated through clearly defined areas. This allows the user to concentrate on the essential points of his measurement without having to decrypt the displayed results.

- 1. Minimized learning time
- 2. User satisfaction
- 3. Minimized error rate
- 4. Better throughput

## Intelligent user follow-up

During the whole using time, the height gauge shows automatically to the user the available options and gives step by step guides through the process. At the same time, a context-based function can be activated at any moment to access to specific information concerning the mode or the active process.

As the user has access to a help, he is constantly guided and is never lost during the use. The context-based help is particularly welcome while learning how to use the gauge.

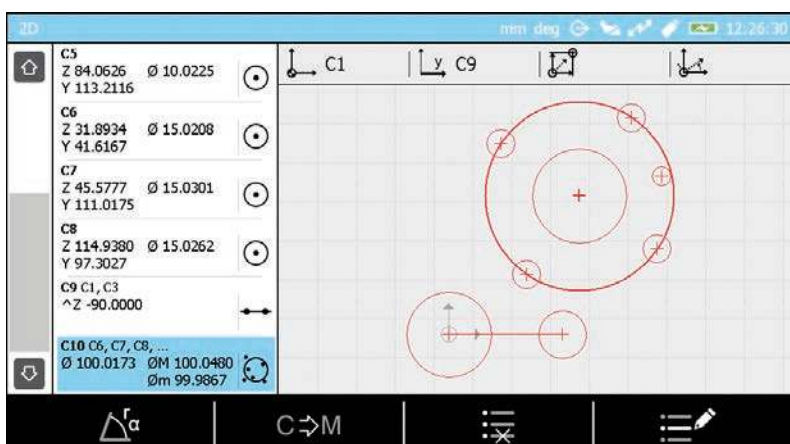
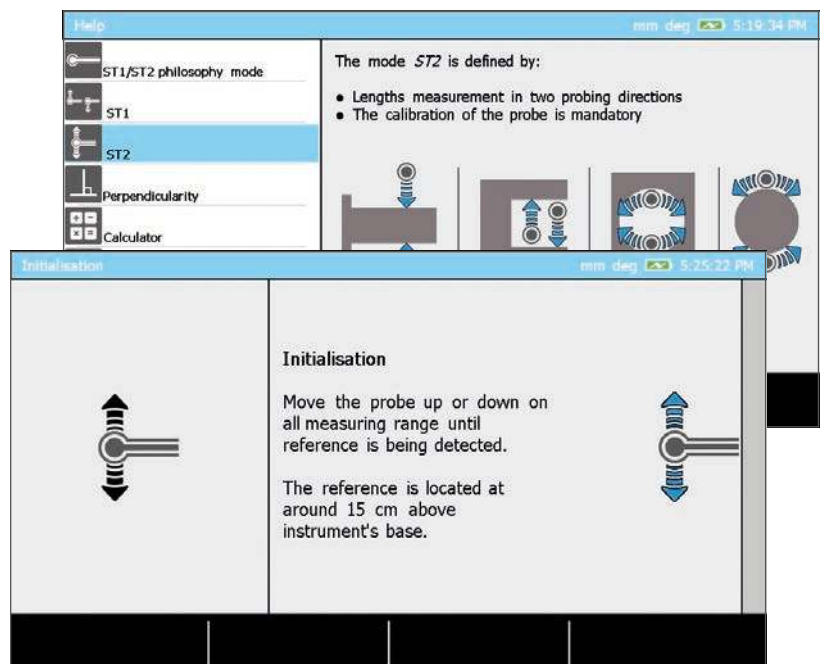

## 2D Advanced functions

As there are as many application cases as parts to measure, TESA developed a software that offers a range of possibilities to measure, going beyond the simple 1D function, like angle measurement, squareness deviation measurement or 2D measurement.

- 1. Multi-task instrument, accessible to everyone
- 2. Unique investment for numerous measuring possibilities
- 3. Quick return on investment

## Customisable functions

With its integrated calculator, the control panel gives the possibility to perform calculations using directly the measuring results and to pre-configure calculation functions that will be automatically activated recalling a measuring program.

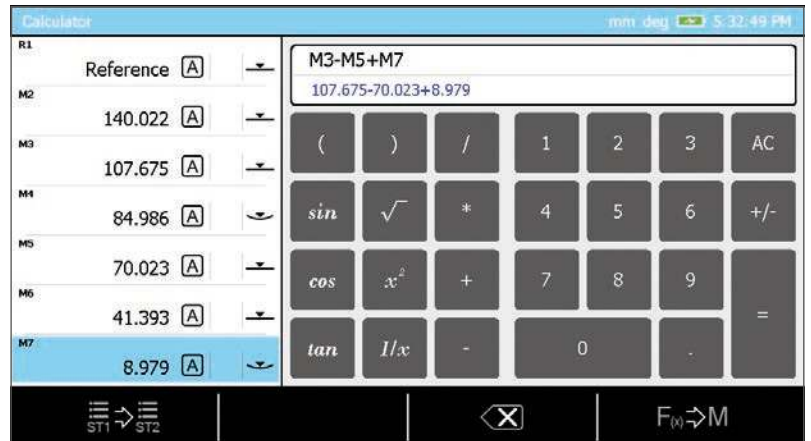

- 1. All instruments integrated = time gain
- 2. Creation of customised calculation functions adopted to real need
- 3. Integrated function to avoid reading errors

## Program management

The height gauges of the range are not only developed to easily perform quick measurements, but they are also thought to simplify sequential measurement of parts of the same batch. Once the measuring sequence is carried out on the first spare part “for learning”, the user can repeat it infinitely following the information displayed on the screen.

- Facilitated sequence creation measuring process. Gain of time and simplification of the process during the measurement of batches.

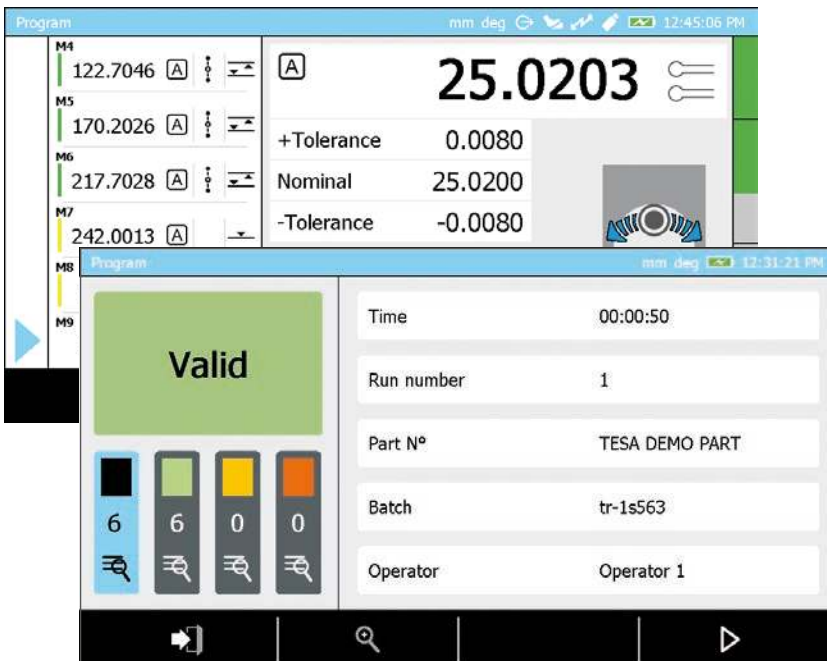

## Clear results

Each part has its own tolerances. The software has been created to allow inserting easily acceptance/reject limits in the most direct possible way. Once the part is measured, the user is explicitly informed about its state.

- Precise and detailed measurement results are displayed to the user (GO/NOGO, rework,...) and managed at the same time by the data backup peripheral devices.

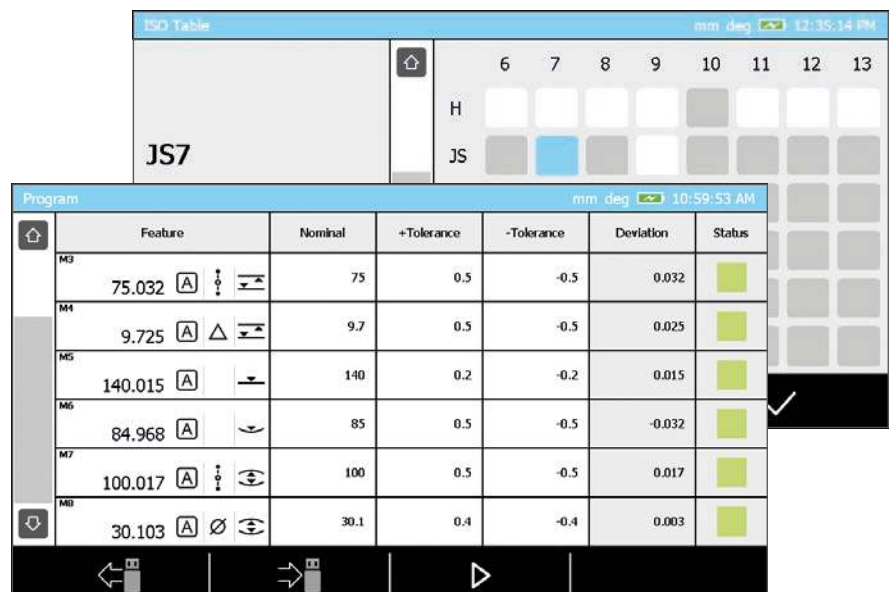



# “FLEXIBLE” DATA MANAGEMENT

The TESA MICRO-HITE height gauges are designed to be flexible, its aim to provide the best data management solutions regardless of the type of user or application.



## Printing

The data can be automatically sent to a printer connected to the panel. The printer is optional and can be connected to a gauge at any time during its use.



## Save on USB stick

The data can be saved in a \*.txt file on a memory stick. Several data formats are available (measured value, and tolerances, ...).



## \*.pdf report

After each execution of a measurement sequence a complete report in \*.pdf format can be created on the USB stick. The report can be customized (insertion of the image of the measured part, the company logo, the operator name or the batch name).



## Connection to a peripheral device

It is possible to connect the instrument to a computer or any other peripheral unit via the TLC (TESA Link Connector) to receive the measuring results on it. This connection can be achieved by cable or wireless. The data can be sent automatically after each measurement or on demand of the user.

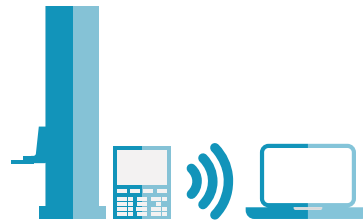
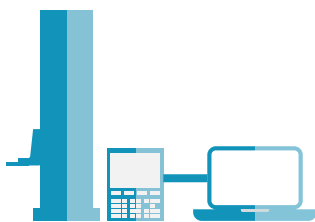

## Direct information

Quick access to measurement information is a key element of a production line performance.

For this purpose, TESA has directly integrated the possibility to insert tolerances for the measured elements. Once the end of a measurement program is reached, the user has the possibility to visualize the detail of his results, which are directly accessible on the instrument panel.



## Retrieve data with ease

Most of the TESA instruments are compatible with the free TESA DATA-VIEWER software, allowing a quick and easy handling of all measurement data. The data is then automatically transferred to files in known formats such as \*.xls, \*.csv, or Q-DAS.



## Fill out a report template in real time

With TESA DATA-DIRECT software, it is possible to measure one or more mechanical parts and to receive automatically formatted data in a report template previously prepared (Excel for example). Once a measurement has been recorded, the report is directly accessible.

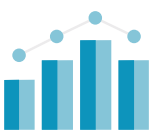
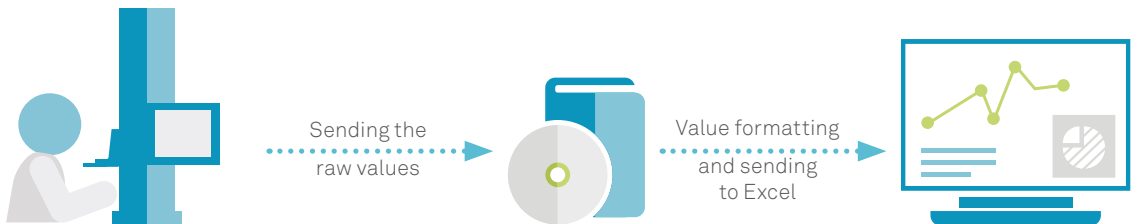

## The quick and easy statistical software

The SPC (Statistical Process Control) TESA STAT-EXPRESS software is the way to calculate in real time all the important characteristics during statistical analyses. Quick to learn, it manages also automatically the measuring reports.



## For demanding statistics

For users with more extensive needs, Q-DAS software will be able to meet the most specific requirements:

- Control and traceability
- Automated data recovery
- Setting up dashboards
- Quality management
- Optimization of production processes
- Supplier quality monitoring

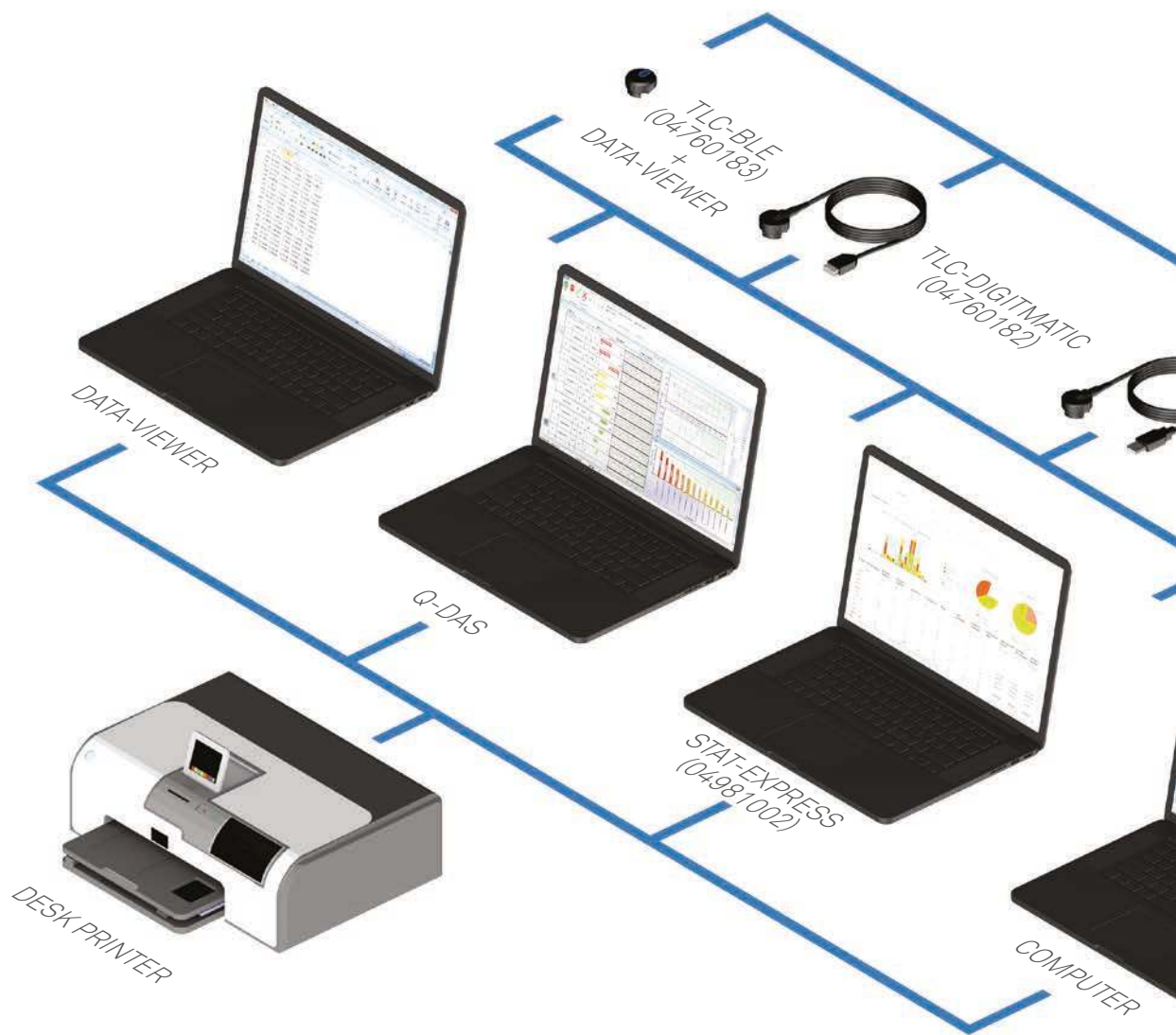

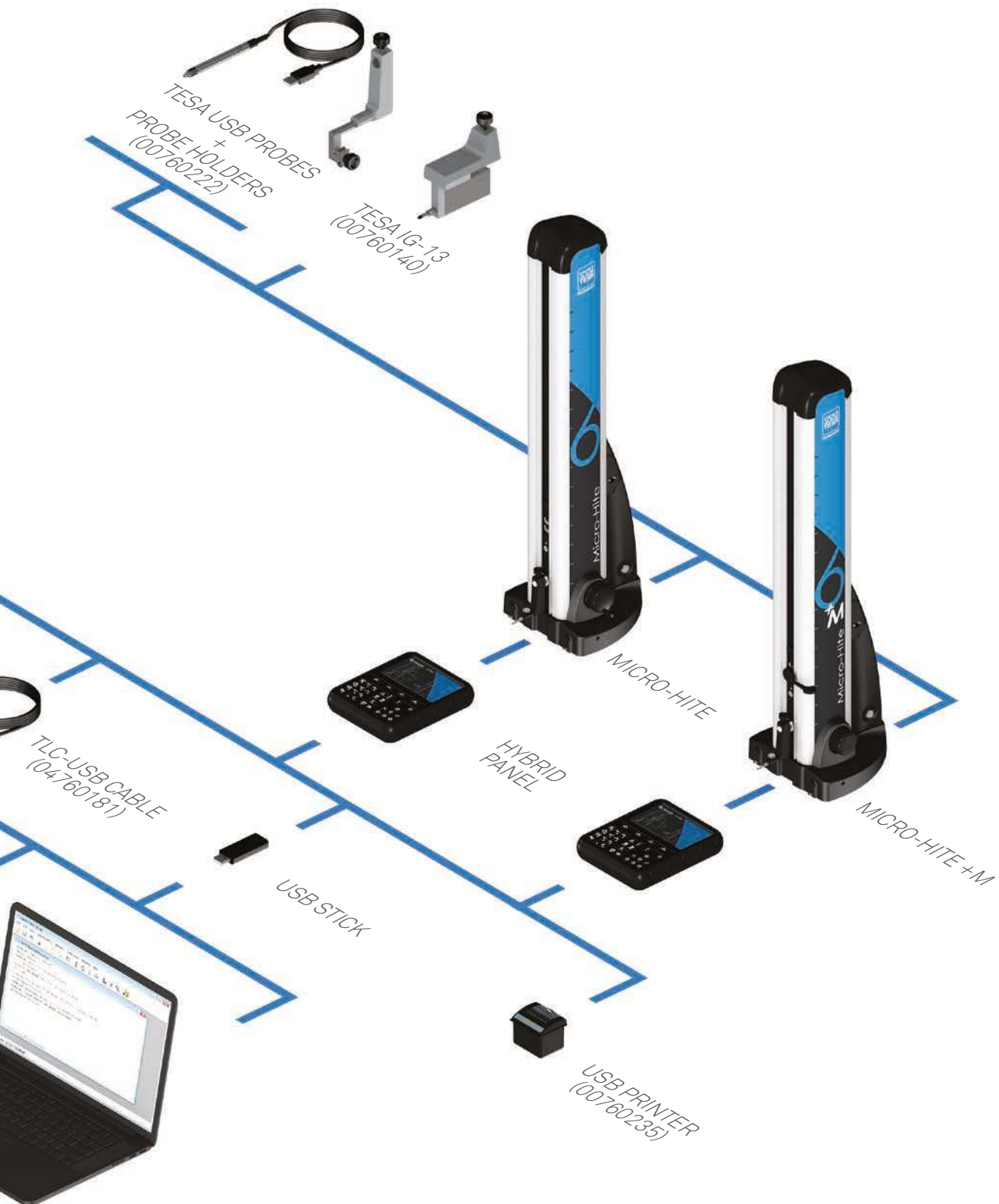



		MICRO-HITE	MICRO-HITE+M
	Probing shortcut		with knob
	Single probing	●	●
	Culmination point	●	●
	Double probing	●	●
	Max, min, delta Parallelism, flatness	●	●
	Perpendicularity Straightness	●	●
	Angle (surface, cone)	●	●
	Embedded calculator Customized functions	●	●
	2D functions	●	●
	References	A/B	A/B
	Distance	●	●
	Mid-point	●	●
	Tolerancing GO/NOGO report	●	●
	mm/inch conversion	●	●
	Context-based help	●	●
	Preset	●	●
	Learning/programming mode	●	●
	Saving on USB key in txt format Automatic creation of pdf report	txt, pdf	txt, pdf
	Send data through TLC port	●	●
	Print data	●	●
	Screen shot	●	●



## CONFIGURATIONS



		MICRO-HITE						MICRO-HITE+M		
Past number		00730073	00730074	00730075	00730076	00730077	00730078	00730079	00730080	00730081
TYPE	Manual displacement	●	●	●	●	●	●			
	Motorised displacement							●	●	●
GAUGE	MICRO-HITE [mm]	350	600	900	350	600	900			
	MICRO-HITE+M [mm]							350	600	900
	Air cushion	●	●	●	●	●	●	●	●	●
	Fine adjustment device				●	●	●			
PANEL	MICRO-HITE panel	●	●	●	●	●	●			
	MICRO-HITE+M panel							●	●	●
	USB printer						optional			
	Adjustable panel support	●	●	●	●	●	●	●	●	●
ACCESSORIES	Ø 6 mm probe holder	●	●	●	●	●	●	●	●	●
	Ø 5 mm probe, hard metal	●	●	●	●	●	●	●	●	●
	12,7 mm / .5 in masterpiece	●	●	●	●	●	●	●	●	●
	Dust cover						optional			
POWER SUPPLY	Removable/reloadable battery	●	●	●	●	●	●	●	●	●
	Power supply	●	●	●	●	●	●	●	●	●
	EUR power cable	●	●	●	●	●	●	●	●	●
	US power cable	●	●	●	●	●	●	●	●	●
OTHERS	SCS certificate	●	●	●	●	●	●	●	●	●
	1 year warranty*	●	●	●	●	●	●	●	●	●
	Maintenance contract						upon request			

\*Register your height gauge on our website and benefit of 3 additional years of warranty.



# MICRO-HITE



For workshops and laboratories



Manual displacements



Air cushion system



With or without fine adjust. device



Adjustable panel



Colour & touch screen



Included SCS certificate



1D & 2D measurement modes



4 years warranty

	MICRO-HITE 350	MICRO-HITE 600	MICRO-HITE 900
Range of application [mm]	520	770	1075
Max. perm. error [ $\mu\text{m}$ ], L [mm]	$2+2L/1000$	$2+2L/1000$	$2+2L/1000$
Repeatability ( $2\sigma$ ) [ $\mu\text{m}$ ]	on surface: $\leq 1$ on arc: $\leq 1$	on surface: $\leq 1$ on arc: $\leq 1$	on surface: $\leq 1$ on arc: $\leq 1$
Max. perp. error with IG13 probe [ $\mu\text{m}$ ]	frontal: 5 lateral: 5	frontal: 7 lateral: 7	frontal: 9 lateral: 9
Max perp. error, mechanical [ $\mu\text{m}$ ]	frontal: 7	frontal: 9	frontal: 11
Autonomy [h]	8	8	8
Trigger force [N]	$1,6 \pm 0,25$	$1,6 \pm 0,25$	$1,6 \pm 0,25$
Panel [mm]	screen, HxL: 84x152 keyboard: backlit	screen, HxL: 84x152 keyboard: backlit	screen, HxL: 84x152 keyboard: backlit
Resolution	0,01 / 0,001 / 0,0001	0,01 / 0,001 / 0,0001	0,01 / 0,001 / 0,0001
Weight (with panel) [kg]	33	37	45

# MICRO-HITE+M



For workshops and laboratories



Motorised displacements



Air cushion system



Adjustable panel



Colour & touch screen



Constant trigger force



Included SCS certificate



1D & 2D measurement modes



4 years warranty

## MICRO-HITE+M 350    MICRO-HITE+M 600    MICRO-HITE+M 900

Range of application [mm]	520	770	1075
Max. perm. error [ $\mu\text{m}$ ], L [mm]	1,8+2L/1000	1,8+2L/1000	1,8+2L/1000
Repeatability ( $2\sigma$ ) [ $\mu\text{m}$ ]	on surface: $\leq 0,5$ on arc: $\leq 1$	on surface: $\leq 0,5$ on arc: $\leq 1$	on surface: $\leq 0,5$ on arc: $\leq 1$
Max. perp. error with IG13 probe [ $\mu\text{m}$ ]	frontal: 5 lateral: 5	frontal: 7 lateral: 7	frontal: 9 lateral: 9
Max perp. error, mechanical [ $\mu\text{m}$ ]	frontal: 7	frontal: 9	frontal: 11
Autonomy [h]	8	8	8
Trigger force [N]	1,6 $\pm$ 0,25	1,6 $\pm$ 0,25	1,6 $\pm$ 0,25
Panel [mm]	screen, HxL: 84x152 keyboard: backlit	screen, HxL: 84x152 keyboard: backlit	screen, HxL: 84x152 keyboard: backlit
Resolution	0,01 / 0,001 / 0,0001	0,01 / 0,001 / 0,0001	0,01 / 0,001 / 0,0001
Weight (with panel) [kg]	33	37	45

# Automobile

The vast majority of motor vehicle components are subject to the fine quality requirements, that imply a commitment to excellence on the part of manufacturers and to propose a flawless product. The height gauges MICRO-HITE and MICRO-HITE+M can be integrated very close to the place of manufacture in order to minimise the impact on the performance of the production chain. The engine components, injection systems and brake systems are examples among multiple applications, which can be measured thanks to the range of gauges available.



00730080  
MICRO-HITE+M 600

00760164  
Ø 5 mm ball probe

00760087  
Probe holder for depth up to 185 mm



Measurement of an engine block

## Moulds and tooling



Measurement of a plastic injection mould for a drill plastic cover

The use of parts made in large series from moulds is nowadays very common and affects all industries, from the food to the aeronautics or the cosmetics industry. For plastic, cast-iron, steel or other materials, the metrological aspect is of paramount importance. It is indeed very often about developing shapes of complex forms and of high precision, regardless of the size of the finished product. The MICRO-HITE or MICRO-HITE+M columns are, hence one of the central parts in order to validate the high quality of these moulds elaboration.



00730080  
MICRO-HITE+M 600

00760094  
Probe with hardened steel rod

# Medical

Like in other industries, the development of products and medical systems is subject to several crucial factors such as performance and cost though primarily to a regulated environment, ..., but first of all to a regulatory environment in which the standards become increasingly high for obvious health reasons.

In this context, companies must constantly adapt to innovate, develop and produce.

The quality of a product used in the medical field is the subject of numerous controls throughout its creation process. Medical Instruments (pumps,...), orthopaedic implants (prostheses, ...) and medical equipment of today often include small components which are receiving greater attention. The MICRO-HITE or MICRO-HITE+M demonstrates the excellence of metrology and are pivotal in the development of medical devices. Upon arrival of the spare parts, numerous protocols and analytical methods are implemented to guarantee the regulatory compliance of products and to have a perfect knowledge before assembling the components in the production line.



## Plasturgy

Metrology is of high importance for the product quality and represents many challenges if it concerns products issued from the assembly of moulded plastic spare parts. Plasturgy is constantly evolving and developing without cease for sectors as vast as the aeronautics, the automotive and the health industry. New plastics emerge regularly (always more environmentally-friendly, less dependent on oil, unbreakable, fireproof, ...). Therefore it is very important to be able to validate the stability of their processes during their development and over the long term. The MICRO-HITE and MICRO-HITE+M height gauges are an essential added value that allows high quality measurements and accelerates new product definition processes.



Measuring centre distances on a plastic casing of an electronic box

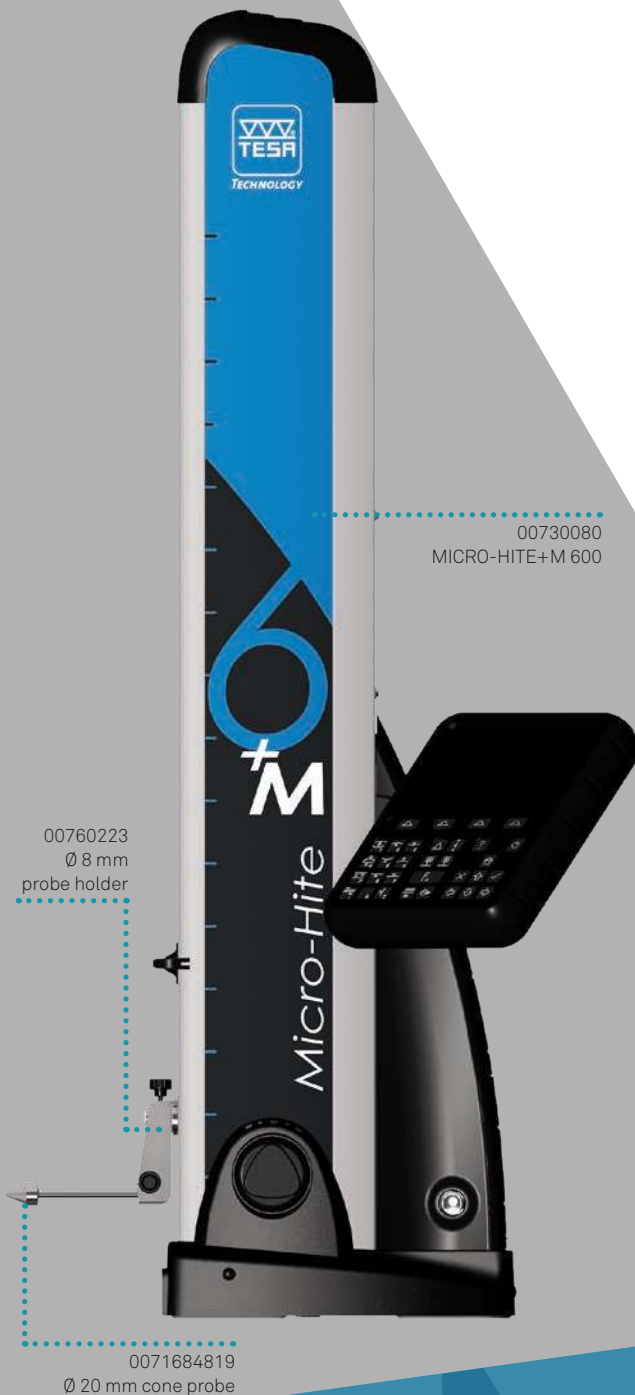

# ACCESSORIES

The TESA height gauges are compatible with a wide range of accessories which allowing the instrument to be customised to meet your real needs.

## Probe holders

Ø 6 mm standard probe holder	00760243	-
Ø 6 mm probe holder	00760086	For depth up to 110 mm
Ø 6 mm probe holder	00760087	For depth up to 185 mm
Ø 6 mm probe holder	00760057	Extend the scope of the application
Ø 6 mm probe holder	S07001622	Extend the scope of the application
Ø 8 mm probe holder	00760223	-
Adapter for M3 probe and shaft	00760177	-
Adapter for M1,4 and M2,5 probes	00760096	3 x M1,4 + 2 x M2,5

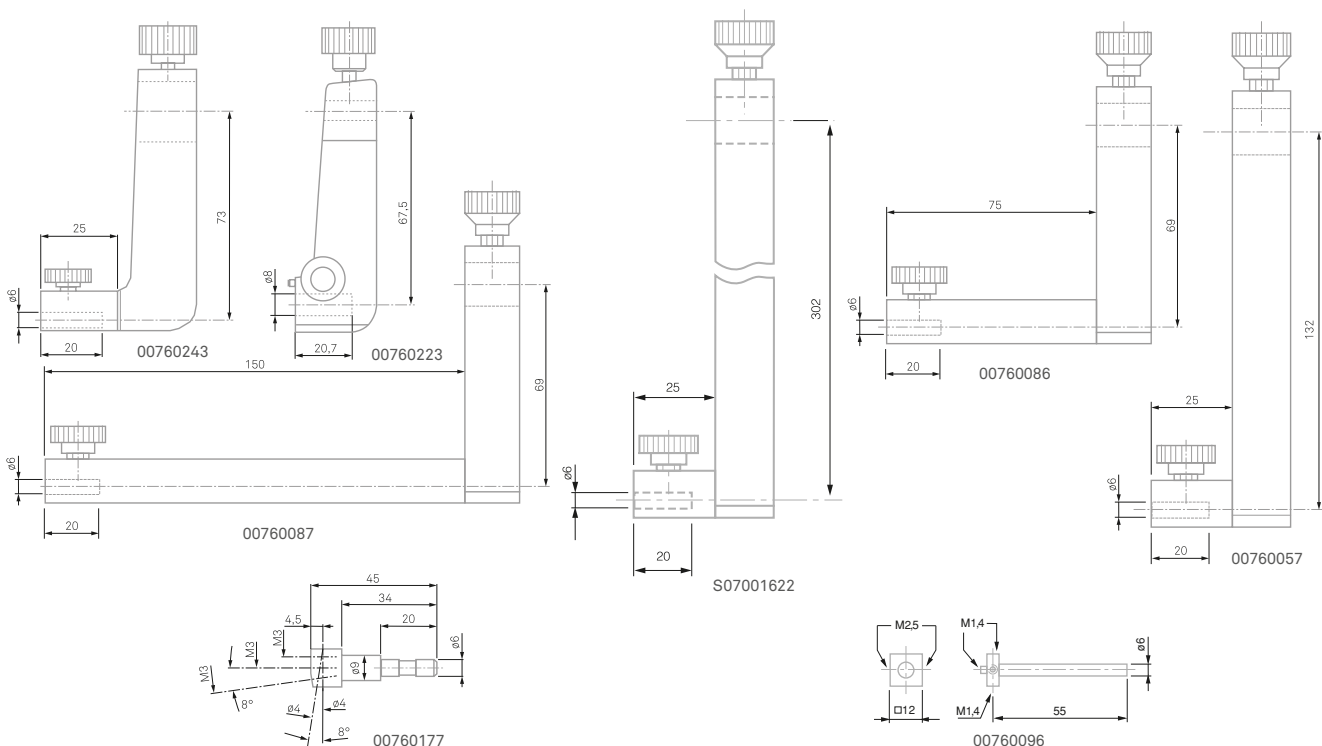
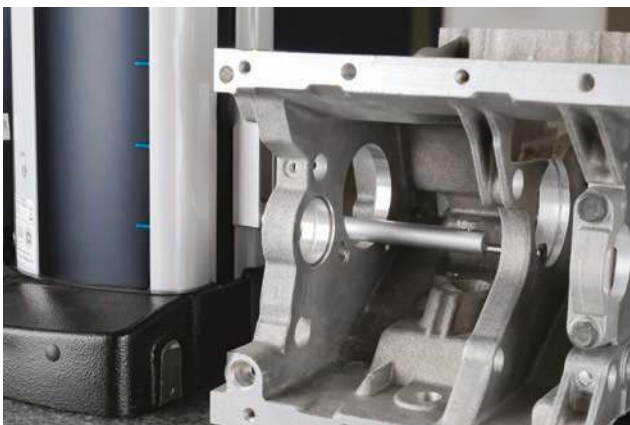



# Ball probes

The ball probes are the easiest and most often used in combination with the height gauges which are furthermore delivered as standard with a probe of this type. Because of its form, these accessories are suitable for the majority of probing applications.

∅ 0,9 mm ball probe	00760180	M3 fixation	Hardened steel ball tip
∅ 1,9 mm ball probe	00760181	M3 fixation	Hardened steel ball tip
∅ 2,9 mm ball probe	00760182	M3 fixation	Hardened steel ball tip
∅ 1 mm ball probe	00760228	∅ 6 mm fixation	Shank and ball tip in hard metal
∅ 2 mm ball probe	00760229	∅ 6 mm fixation	Shank and ball tip in hard metal
∅ 3 mm ball probe	00760230	∅ 6 mm fixation	Shank and ball tip in hard metal
∅ 3 mm ball probe	00760061	∅ 6 mm fixation	Ball tip in hard metal
∅ 5 mm ball probe	00760227	∅ 6 mm fixation	Shank and ball tip in hard metal
∅ 10 mm ball probe	00760060	∅ 6 mm fixation	Ball tip in hard metal
∅ 1 mm ball probe	0071684818	∅ 8 mm fixation	Adjustable shank for depth measurement
∅ 4 mm ball probe	0071684815	∅ 8 mm fixation	Ball tip in hard metal
∅ 6 mm ball probe	0071684825	∅ 8 mm fixation	Ball tip in hard metal
∅ 6 mm ball probe	0071684816	∅ 8 mm fixation	Ball tip in hard metal
∅ 8 mm ball probe	0071684832	∅ 8 mm fixation	Ball tip in hard metal
∅ 10 mm ball probe	0071684817	∅ 8 mm fixation	Ball tip in hard metal
∅ 10 mm ball probe	0071684829	∅ 8 mm fixation	Ball tip in hard metal

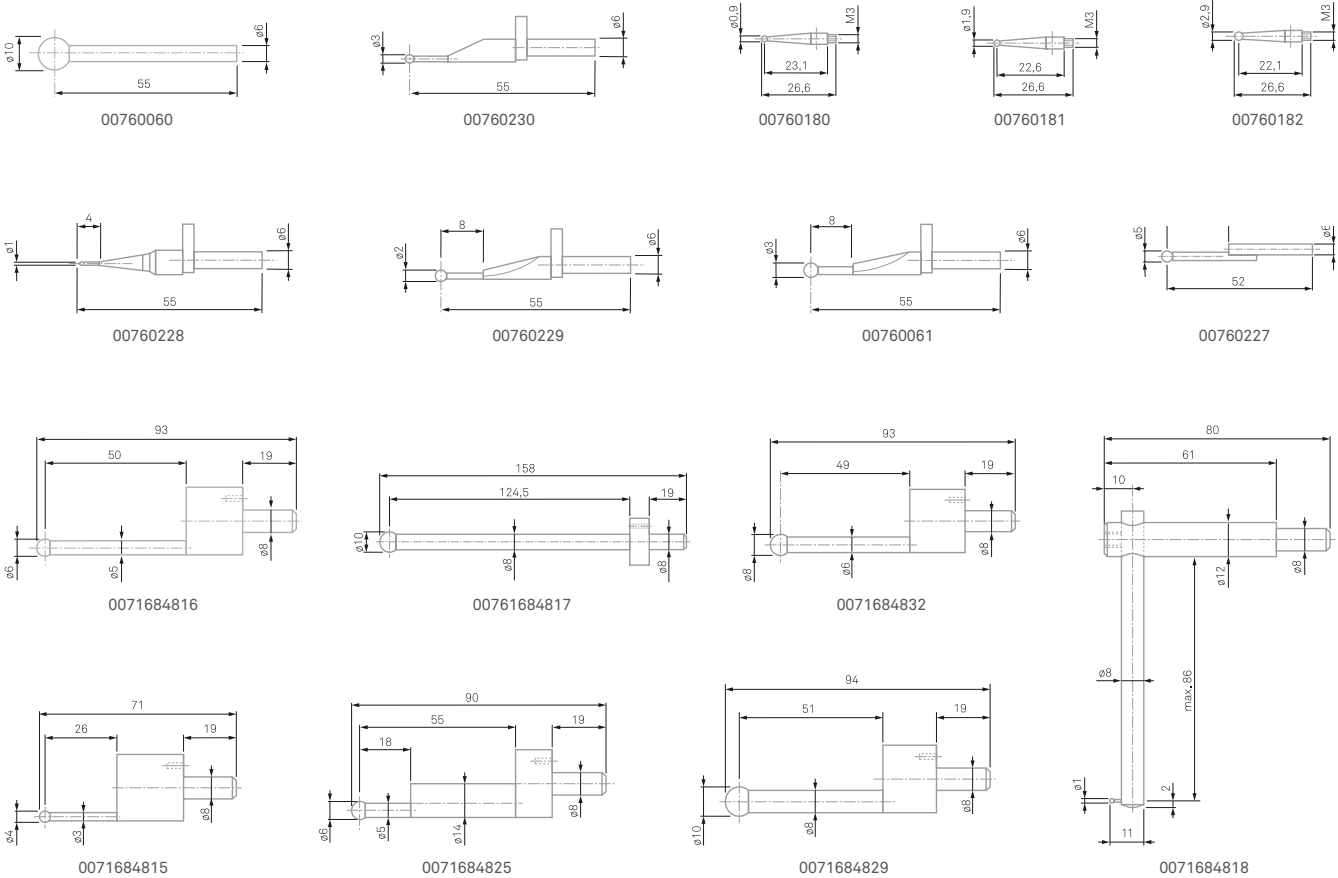

# Disc probes

These probes have the form of a disc with a variable thickness and diameter, allowing the probing of centring shoulders and grooves. These accessories are often used in internal bore measurements because they are a good replacement when the star-formed probes cannot be used.

Disc probe Ø 4,5 mm	00760074	Ø 6 mm fixation, hard metal disc
Disc probe Ø 14 mm	00760075	Ø 6 mm fixation, hard metal disc
Disc probe Ø 19 mm	00760076	Ø 6 mm fixation, hard metal disc
Disc probe Ø 12 mm	0071684827	Ø 8 mm fixation

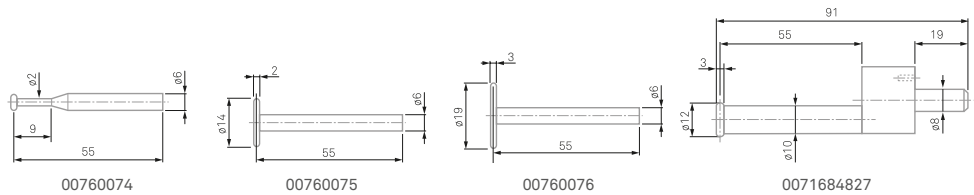

# Cone probes

Cone probes are mainly used to determine the location of a bore since their form allows a quick positioning at the centre of these elements.

Cone probe Ø 8 mm	00760183	M3 fixation, hardened steel
Cone probe Ø 6 mm	0071684822	Ø 8 mm fixation, hardened steel
Cone probe Ø 22 mm	0071684819	Ø 8 mm fixation, hardened steel

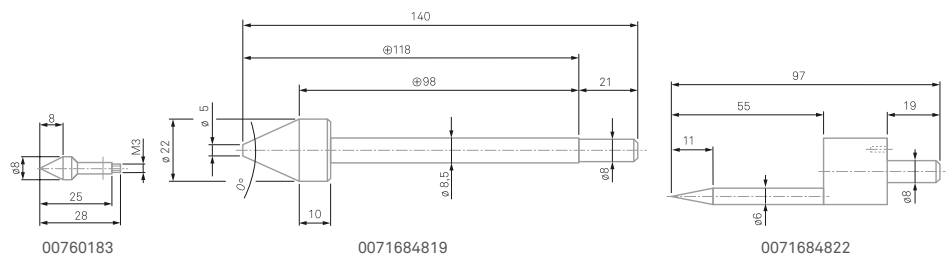

# Shaft probes

The shaft probes are mainly used to measure grooves, centring shoulders, blind bores, ...

Probe inserts with a shank	00760094	hardened steel
Rod, angle 8°	00760178	hardened steel
Cylindrical rod	00760179	hard metal

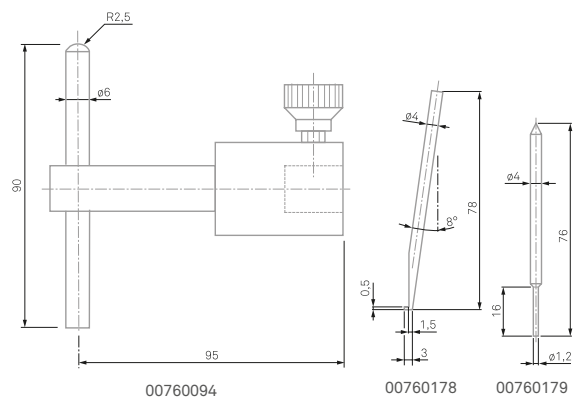

# Cylindrical or barrel probes

The cylinder-shaped probes are often used to measure elements that cannot or hardly not easily be measured with a simple ball probe. In some instances, the contact between the accessory and the part to be measured cannot be guaranteed when the tip of the accessory is a ball. They are also used for the measurement of threads and often for the determination of the centre of tapped bores.

Barrel-shaped probe Ø 2,2 mm	00760066	Ø 6 mm fixation, hard metal measuring faces
Barrel-shaped probe Ø 4,5 mm	00760067	Ø 6 mm fixation, hard metal measuring faces
Barrel-shaped probe Ø 9,7 mm	00760068	Ø 6 mm fixation, hard metal measuring faces
Cylinder-shaped probe Ø 2 mm	00760082	Ø 6 mm fixation, hard metal measuring faces
Cylinder-shaped probe Ø 10 mm	00760093	Hardened steel housing, hard metal measuring faces
Cylinder-shaped probe Ø 10 mm	0071684820	Ø 8 mm fixation, steel

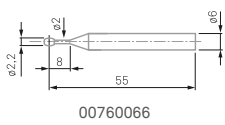

00760066

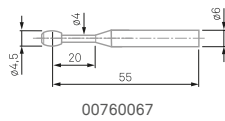

00760067

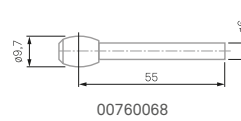

00760068

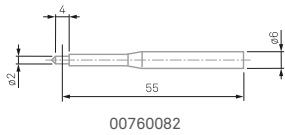

00760082

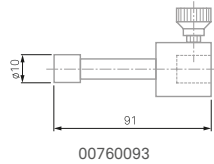

00760093

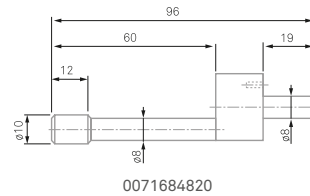

0071684820



# Accessories for squareness measurement

In addition to the standard measuring modes, the manual and motorized models of the MICRO-HITE range have been specially developed to allow the determination of perpendicularity or straightness errors. The measurements can be realized in two directions, as these gauges are the only ones on the market allowing this measurement as well frontally as laterally.

Probe holder Ø 8 mm	00760222	for a lever dial test indicator or a 1D probe
IG13 probe	00760139	-
Attachment system for IG13	00760138	-
IG13 probe set	00760140	= 00760139 + 00760138
IG13/height gauge adapter	00760247	To use together with IG13 delivered before 2017
1D USB probe GT61*	03230204	To use together with probe holder 00760222

\*Any other 1D USB TESA probe is also compatible

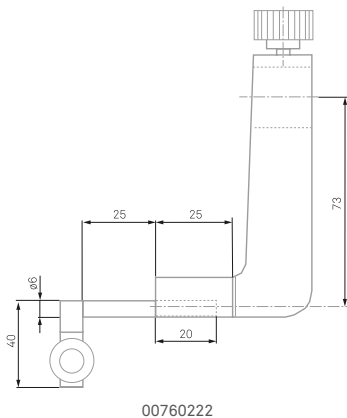

00760222

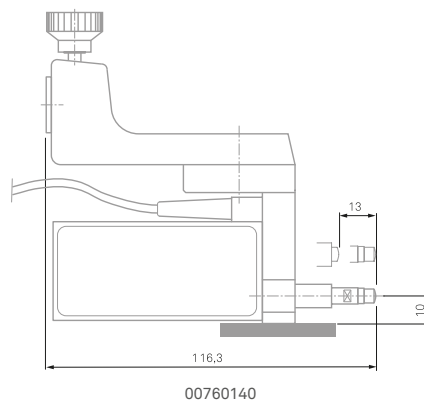

00760140



# SETS OF ACCESSORIES

		Kit 1 4 elements 00760232	Kit 2 8 elements 00760173	Kit 3 17 elements 00760148	Kit 4 9 elements 00760175	
<b>Composed of</b>						
Probe holders	00760057	Ø 6 mm probe holder to extend the application range		●		
	00760086	Ø 6 mm probe holder for depth up to 110 mm		●		
	00760087	Ø 6 mm probe holder for depth up to 185 mm		●		
	00760177	Adapter for M3 probes			●	
Probes	00760060	Ø 10 mm ball probe, Ø 6 mm fixation		●	●	
	00760061	●	●	●		
	00760066	Ø 2,2 mm barrel-shaped probe, Ø 6 mm fixation		●		
	00760067	Ø 4,5 mm barrel-shaped probe, Ø 6 mm fixation		●		
	00760068	Ø 9,7 mm barrel-shaped probe, Ø 6 mm fixation		●		
	00760074	Ø 4,5 mm disc probe, Ø 6 mm fixation		●		
	00760075	●	●	●		
	00760076	Ø 19 mm disc probe, Ø 6 mm fixation		●		
	00760082	●		●		
	00760093	Ø 10 mm cylinder-shaped probe		●	●	
	00760094	●	●	●		
	00760180	Ø 0,9 mm ball probe, M3 fixation			●	
	00760181	Ø 1,9 mm ball probe, M3 fixation			●	
	00760182	Ø 2,9 mm ball probe, M3 fixation			●	
	00760183	Ø 8 mm cone probe, M3 fixation			●	
	00760228	Ø 1 mm ball probe, Ø 6 mm fixation		●	●	
	00760229	Ø 2 mm ball probe, Ø 6 mm fixation		●	●	
	00760230	Ø 3 mm ball probe, Ø 6 mm fixation		●	●	
	Extensions	00760184	Extension M3, L 20 mm			●
		00760185	Extension M3-M2,5, L 20 mm			●
Shaft probes	00760178	Steel rod, angle 8°			●	
	00760179	Hard metal cylindrical rod			●	

# OTHER ACCESSORIES

Data Management	USB printer	00760235	-
	Thermal paper for USB printer	00760250	Pack of 4 rolls
	TESA DATA-DIRECT software	04981001	For data formatting
	TESA STAT-EXPRESS software	04981002	SPC software
	Q-DAS software (qs-STAT, ...)	-	Please contact your local dealer
	TLC-DIGIMATIC cable	04760182	-
	TLC-USB cable	04760181	-
	TESA TLC-BLE emitter (Bluetooth®)	04760184	-
	USB dongle receiver + 1,5 m cable	04760185	For use with 04760184
	TESA TLC-BLE starter kit	04760183	= 04760184 + 04760185
Cleaning and protection	Hand switch	04768000	Cable L = 1,8 m
	Foot switch	04768001	Cable L = 1,8 m
	Dust cover, 350 mm	00760151	-
	Dust cover, 600 mm	00760152	-
Electric power supply	Dust cover, 900 mm	00760153	-
	Cleaning liquid	00760249	For granite table
	Battery block	00760244	Rechargeable, interchangeable
	Battery recharging station	00760245	For 00760244 battery
	Battery set	00760252	= 00760244 + 00760245
	Charger	00760251	-
	Charger cable	04761055	For Europe
Others	Charger cable	04761056	For USA
	Charger cable	04761072	For UK
	Fine adjustment kit	00760246	For manual MICRO-HITE
	Practice part	00760124	-

# THE TESA SERVICE, OUR PRIORITY

For TESA, customer care is essential. To satisfy the most demanding metrological expectations of our clients and to help them find solutions is our daily challenge.



## Calibration

To preserve the accuracy of measurement of your tools, TESA controls and calibrates your equipment and delivers a SCS accreditation (Swiss Calibration Service) or a TESA measuring report.



## Repairs

Your height gauge needs to be repaired? TESA proposes quick solutions to repair, exchange and rent, if your equipment is under warranty or not.



## Support

A product support and technical support are available for TESA equipment.



## Training

A whole range of courses has been designed to meet your needs: user training during the installation, product training at TESA headquarters as well as on-site and customised trainings.



## Maintenance

Work with peace of mind thanks to the preventive TESA maintenance contract to extend the life of your equipment and to preserve their precision.



## Customization of the measuring inserts

For any requirements of specific measures, TESA proposes to customise your measuring insert according to your wishes.



## 4 years warranty

Our increasingly high quality standards allow us today to offer you four years of warranty. This allows you to concentrate on your expertise with peace of mind.





**HEXAGON**  
MANUFACTURING INTELLIGENCE

Hexagon Manufacturing Intelligence helps industrial manufacturers develop the disruptive technologies of today and the life-changing products of tomorrow. As a leading metrology and manufacturing solution specialist, our expertise in sensing, thinking and acting – the collection, analysis and active use of measurement data – gives our customers the confidence to increase production speed and accelerate productivity while enhancing product quality.

Through a network of local service centres, production facilities and commercial operations across five continents, we are shaping smart change in manufacturing to build a world where quality drives productivity. For more information, visit [HexagonMI.com](http://HexagonMI.com).

Hexagon Manufacturing Intelligence is part of Hexagon (Nasdaq Stockholm: HEXA B; [hexagon.com](http://hexagon.com)), a leading global provider of information technologies that drive quality and productivity across geospatial and industrial enterprise applications.

-  COORDINATE MEASURING MACHINES
-  3D LASER SCANNING
-  SENSORS
-  PORTABLE MEASURING ARMS
-  SERVICES
-  LASER TRACKERS & STATIONS
-  MULTISENSOR & OPTICAL SYSTEMS
-  WHITE LIGHT SCANNERS
-  METROLOGY SOFTWARE SOLUTIONS
-  CAD / CAM
-  STATISTICAL PROCESS CONTROL
-  AUTOMATED APPLICATIONS
-  MICROMETERS, CALIPERS, HEIGHT GAGES, ETC...
-  DESIGN AND COSTING SOFTWARE



**TESA**  
TECHNOLOGY

Established in 1941 and headquartered in Renens, Switzerland, TESA manufactures and markets precision measuring instruments that stand for quality, reliability and longevity.

For more than 75 years, TESA has distinguished itself in the market through its excellent products, its unique expertise in micromechanics and precision machining as well as its proven experience in dimensional metrology.

The TESA brand is the global market leader in the field of height gauges and a pioneer thanks to its wide range of instruments, including callipers, micrometers, dial gauges,

lever-type dial test indicators and inductive probes. TESA is a true benchmark for the inspection of incoming goods, as well as for production workshops and quality assurance laboratories.

Through its worldwide distribution network the company focuses on the mechanical engineering, micromechanical, automotive, aerospace, watchmaking and medical industries.

In 2001, TESA became part of Hexagon, a leading global provider of information technologies.

[TESAtechnology.com](http://TESAtechnology.com)