

-  DIN 862 (Style 1AN-2) NFE 11-091
-  Maximum permissible errors, in accordance with standard
-  Hardened stainless steel
-  Inspection report with a declaration of conformity
-  Satin-chrome scale background; main scale slightly set back for protection against wear

VERNIER CALIPERS





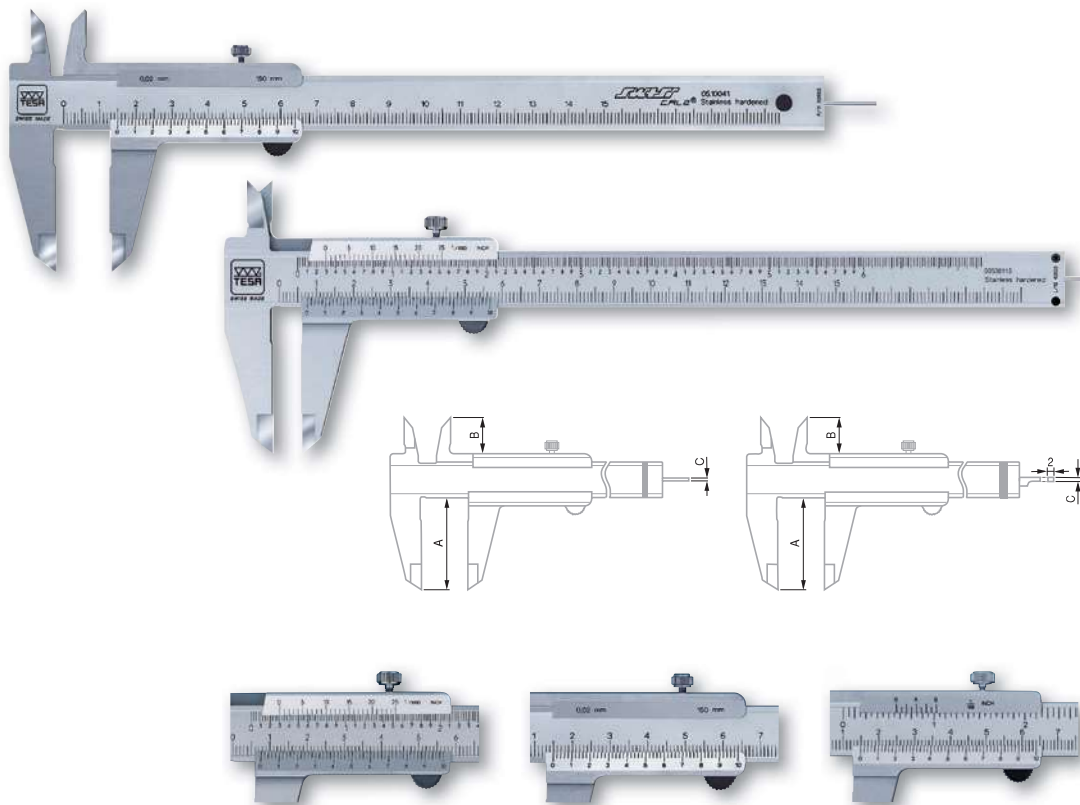

The simplest calipers to use with engraved scales for reading very fine divisions on measurements.

Standard Models

Calipers offering great value for money:

- Fitted with a locking screw.
- With rectangular or round depth rod.



No	=							
		mm	in	mm	in	A mm	B mm	C mm
00510041	SWISSCAL 2	0 ÷ 150	-	0,02	-	40	15,5	Ø 1,5
00510047	Standard	0 ÷ 150	-	0,05	-	40	15,5	Ø 1,5
00530103	Standard	0 ÷ 150	0 ÷ 6	0,05	1/128	40	15,5	Ø 1,5
00530104	Standard	0 ÷ 200	0 ÷ 8	0,05	1/128	50	18	1,5 x 2
00530105	Standard	0 ÷ 300	0 ÷ 12	0,05	1/128	64	22	-
00530110	Standard	0 ÷ 150	0 ÷ 6	0,02	0.001	40	15,5	Ø 1,5
00530111	Standard	0 ÷ 200	0 ÷ 8	0,02	0.001	50	18	1,5 x 2
00530112	Standard	0 ÷ 300	0 ÷ 12	0,02	0.001	64	22	-
00530120	Self-locking model	0 ÷ 150	0 ÷ 6	0,05	1/128	40	15,5	1,5 x 2
00530121	Self-locking model	0 ÷ 150	0 ÷ 6	0,02	0.001	40	15,5	1,5 x 2
00530130	Self-locking model with parallax-free readout	0 ÷ 150	0 ÷ 6	0,05	1/128	40	15,5	1,5 x 2
00530131	Self-locking model with parallax-free readout	0 ÷ 150	0 ÷ 6	0,02	0.001	40	15,5	1,5 x 2

OPTIONAL ACCESSORIES:

00560013	Depth foot for calipers up to 150 mm
0051610365	Magnetic magnifying glass, 3x magnification

