

# Absolute Arm systems and accessories

Version 2.3





## Symbols

- ☑ : standard delivery
- ✓ : compatible with the item or accessory
- : incompatible with the item or accessory
- : mandatory accessory
- opt: optional accessory
- ⊘ : not in standard delivery

This catalogue contains the complete range of products and accessories available for Absolute Arm systems from Hexagon. Whatever the industry or application, the Absolute Arm has a solution.

All systems and accessories offer the same high-end, straight-forward design and quality users expect from Hexagon products.



### | [shop.hexagonmi.com](https://shop.hexagonmi.com)

Hexagon Manufacturing Intelligence's online shop offers a streamlined search, order, and delivery service for a wide range of accessories and spare parts in many countries worldwide. Your benefits:

- Quickly find the right inspection solution with the shop's state-of-the-art search function: filter by price, radius, thread, and other criteria to pinpoint the exact product required
- Fast UPS dispatch
- Easy bulk purchase via CSV file uploads
- Convenient payment – on account or by credit card

Whether you're buying in bulk or single items, [shop.hexagonmi.com](https://shop.hexagonmi.com) takes the time and stress out of securing the measuring equipment you need.

Please direct any questions about Hexagon products or accessories to an authorised local sales representative to receive guidance and assistance in making an appropriate purchasing decision.

#### **Important note**

The information provided by Hexagon in this catalogue is for general information purposes only. All information and arm configurations subject to change without further notice.

The images in this document are for reference only and are subject to change without notice. The colour, shape and weight of the products represented here may be different from those delivered.

Copyright and Intellectual Property: All elements of this document (including trademarks, text, graphics, logos, photos, etc.) are the property of Hexagon AB in the United States and selected other countries. Therefore, any reproduction and/or representation and/or redistribution in whole or in part, in any electronic form or not, present or future, is prohibited unless express consent is given.





## Contents

Applications	6
Absolute Arm systems	9
Probes and scanners	23
Mounting solutions	39
Artefacts and certifications	47
Accessories for tube inspection	53
Volume extensions	59
Other accessories	63
Application software	71
Warranty and maintenance	83

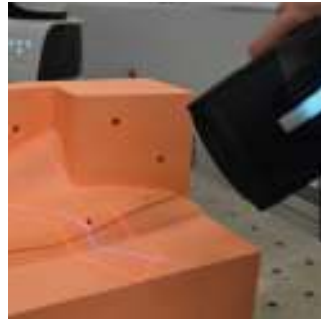

Jig and fixture  
 Build and inspect  
 Tube and wire

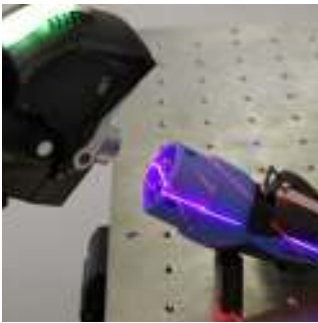

Sheet metal  
 Mould and die  
 Shop floor



Gear measurement

On-machine  
verification

Maintenance  
and repair



CAD-to-part  
Reverse engineering  
Virtual assembly



Composite  
inspection  
In-process checks  
Digitising





# Absolute Arm systems

Overview	10
Absolute Arm 7-Axis   83, 85 and 87 series	13
Absolute Arm 6-Axis   83, 85 and 87 series	16
Absolute Arm Compact   83 and 85 series	19
Absolute Arm Tube   83 Series	21



### Accuracy

The Absolute Arm range offers probing accuracy as fine as only 6 microns and scanning system accuracy to within 43 microns.



### Speed

The RS-SQUARED is designed to obtain data sets of large simple objects in the shortest possible time, while the AS1 is designed for high-speed scanning of highly detailed parts.



### Convenience

Even the largest Absolute Arm weighs less than 11 kilograms, making set-up and repositioning a quick and easy process.



### Resilience

The robust and shock-resistant carry case keeps the arm properly protected and in perfect condition wherever and however it's transported.



### Productivity

The SHINE technology of the Absolute Scanner AS1 takes data quality to a new level without compromising on speed, while the ground-breaking RS-SQUARED Area Scanner brings ultra-fast structured light scanning to a portable measuring arm for the first time.



### Connectivity

Industry 4.0 ready with full 300 Hertz scanning performance over WiFi and simple integration within Hexagon's Smart Factory concept.



### Repeatability

A patented kinematic probe joint minimises downtime by allowing all probes to be swapped on the fly with no need for recalibration.



### Monitoring

The SMART – Self-Monitoring Analysis and Reporting Technology – system provides full diagnostic monitoring for comprehensive measurement reliability.



### Compatibility

An established and reliable software interface that is compatible with and supported by all major portable metrology software packages.



### Certification

Probing accuracy certified according to ISO 10360-12 as standard, along with full scanning system accuracy according to ISO 10360-8 Annex D. User accuracy verification supported by supplied CMM-certified artefact.

## Encoders

Patented **Absolute Encoders** within every articulated joint are exclusive to Hexagon and make the Absolute Arm the only portable measuring arm that has completely eliminated warm-up times and encoder referencing before use.

## Movement

The unique **Zero-G Counter Balance** system and low-friction rotating grips reduce user fatigue and maximise accuracy by minimising inertia.

## Measurement

Multi-functional control buttons and a convenient **OLED wrist display** screen put measurement control directly in the user's hand, while a range of probes and 3D scanners deliver flexible measurement functionality.

## Feedback

Easy user interaction in even the harshest industrial environments through **visual, acoustic and haptic** feedback functions, now augmented with Bluetooth technology.

## Materials

High-tech **carbon-fibre tube** construction ensures strength and thermal stability under any environmental conditions.

## Security

The **HomeDock** and **SmartLock** features allow the arm to be stowed and locked in place between measurements, for greater security during transport, set-up and station moves.

## Portability

True **wireless** connectivity and **hot-swappable batteries** give greater flexibility when moving the arm around the shop floor, along with **full WiFi** scanning performance with our rapid laser and structured light scanners.



## Accuracy Specifications

All probing specifications are achieved with an Absolute Arm mounted on a standard base plate or magnetic base (as available in this catalogue) under stable environmental conditions. This level of equipment accuracy is not guaranteed with other stands and volume extension products.

## Nomenclature

# RA8525-7

-7	7-Axis model
-6	6-Axis model
-T	Tube model
12	1.2 m measuring volume
20	2.0 m measuring volume
25	2.5 m measuring volume
30	3.0 m measuring volume
35	3.5 m measuring volume
40	4.0 m measuring volume
45	4.5 m measuring volume
87	series - Ultimate solution for portable high-accuracy measurement
85	series - Perfect balance between value and accurate measurement
83	series - Entry-level measurement accuracy

## Absolute Arm 7-Axis wrist packages

	Removable pistol grip	Fixed pistol grip	3 sizes hand grips	Nose cone	AS1 Laser Scanner	RS5 Laser Scanner	RS-SQUARED Area Scanner	Fixed adaptor	Alignment sphere	Alignment plate
H00007281 - Probing kit	<input checked="" type="checkbox"/>	<input type="checkbox"/>	<input checked="" type="checkbox"/>	<input checked="" type="checkbox"/>	<input type="checkbox"/>	<input type="checkbox"/>	<input type="checkbox"/>	<input type="checkbox"/>	<input checked="" type="checkbox"/>	<input type="checkbox"/>
H000027249 - AS1 kit	<input checked="" type="checkbox"/>	<input type="checkbox"/>	<input checked="" type="checkbox"/>	<input checked="" type="checkbox"/>	<input checked="" type="checkbox"/>	<input type="checkbox"/>	<input type="checkbox"/>	<input type="checkbox"/>	<input checked="" type="checkbox"/>	<input type="checkbox"/>
H00007293 - RS5 kit	<input checked="" type="checkbox"/>	<input type="checkbox"/>	<input checked="" type="checkbox"/>	<input checked="" type="checkbox"/>	<input type="checkbox"/>	<input checked="" type="checkbox"/>	<input type="checkbox"/>	<input type="checkbox"/>	<input checked="" type="checkbox"/>	<input type="checkbox"/>
H000013115 - RS-SQUARED kit	<input checked="" type="checkbox"/>	<input type="checkbox"/>	<input checked="" type="checkbox"/>	<input checked="" type="checkbox"/>	<input type="checkbox"/>	<input type="checkbox"/>	<input checked="" type="checkbox"/>	<input type="checkbox"/>	<input type="checkbox"/>	<input checked="" type="checkbox"/>
H00007294 - External scanning	<input type="checkbox"/>	<input checked="" type="checkbox"/>	<input checked="" type="checkbox"/>	<input type="checkbox"/>	<input type="checkbox"/>	<input type="checkbox"/>	<input type="checkbox"/>	<input checked="" type="checkbox"/>	<input checked="" type="checkbox"/>	<input type="checkbox"/>

\*Certified chrome sphere for probing only.

## Control packs

	Power AC	Battery		Ethernet to-USB adaptor	WiFi		Ethernet cable		Scanners					
		Arm	Scanner		Arm	Scanner	Arm	Scanner	AS1	RS5	RS-SQUARED	HP-L-8.9	APODIUS 3D	
H00015423-01 Connector Pack (CP-C)***	<input checked="" type="checkbox"/>	<input type="checkbox"/>	<input type="checkbox"/>	<input checked="" type="checkbox"/>	<input type="checkbox"/>	<input type="checkbox"/>	<input checked="" type="checkbox"/>	<input checked="" type="checkbox"/>	<input checked="" type="checkbox"/>	<input checked="" type="checkbox"/>	<input checked="" type="checkbox"/>	<input checked="" type="checkbox"/>	<input checked="" type="checkbox"/>	<input checked="" type="checkbox"/>
H00012444-01 Wireless Pack (CP-W)***	<input checked="" type="checkbox"/>	<input checked="" type="checkbox"/>	<input checked="" type="checkbox"/>	<input checked="" type="checkbox"/>	<input checked="" type="checkbox"/>	<input checked="" type="checkbox"/>	<input checked="" type="checkbox"/>	<input checked="" type="checkbox"/>	<input checked="" type="checkbox"/>	<input checked="" type="checkbox"/>	<input checked="" type="checkbox"/>	<input checked="" type="checkbox"/>	<input checked="" type="checkbox"/>	<input checked="" type="checkbox"/>

\*\* HP-L-8.9 and APODIUS 3D sensors do not support WiFi scanning.

\*\*\* Includes a 3-metre ethernet cable and Gigabit ethernet adaptor.

# Absolute Arm 7-Axis 83 series

7-axis portable measuring arm for all-purpose tactile measurement and scanning functionality, including:

- Zero-G Counterbalance
- SmartLock + HomeDock
- Base plate
- TKJ 3-mm / 6-mm / 15-mm ball probes
- RDS calibration and interface software
- Wrist display
- Travel case
- Certified alignment sphere for probing/scanning
- ISO 10360-12 certification (for articulated arms for tactile measurement)
- 24-month warranty

H00008000-03-8320	<b>Absolute Arm 8320-7</b> 2.0 m measurement volume
H00008000-03-8325	<b>Absolute Arm 8325-7</b> 2.5 m measurement volume
H00008000-03-8330	<b>Absolute Arm 8330-7</b> 3.0 m measurement volume
H00008000-03-8335	<b>Absolute Arm 8335-7</b> 3.5 m measurement volume
H00008000-03-8340	<b>Absolute Arm 8340-7</b> 4.0 m measurement volume
H00008000-03-8345	<b>Absolute Arm 8345-7</b> 4.5 m measurement volume

<b>Encoder</b>	Absolute Encoders	<input checked="" type="checkbox"/>
<b>Movement and security</b>	Zero-G Counterbalance   SmartLock   Home-Dock	<input checked="" type="checkbox"/>
<b>Display</b>	OLED wrist display   LED pictograms	<input checked="" type="checkbox"/>
<b>Haptic feedback</b>	Wrist vibration	<input checked="" type="checkbox"/>
<b>Cables</b>	3-metre ethernet cable   Gigabit ethernet adaptor   Power supply	<input checked="" type="checkbox"/>
<b>Mounting base</b>	Standard base plate with mounting ring	<input checked="" type="checkbox"/>
<b>Probes</b>	TKJ L 50 – ø 15-mm stainless steel	<input checked="" type="checkbox"/>
	TKJ L 50 – ø 6-mm ruby	<input checked="" type="checkbox"/>
	TKJ L 50 – ø 3-mm ruby	<input checked="" type="checkbox"/>
<b>Packaging</b>	Hard case	<input checked="" type="checkbox"/>
	Accessories case	<input checked="" type="checkbox"/>
<b>Dust cover</b>	Dust cover, Hexagon-branded	<input checked="" type="checkbox"/>
<b>Software</b>	USB Standard Package: RDS driver and interface	<input checked="" type="checkbox"/>
	User manuals	<input checked="" type="checkbox"/>



<b>Control Pack</b>	Connector pack (CP-C)	<input type="checkbox"/>
	Wireless pack (CP-W)	<input type="checkbox"/>
<b>Artefacts*</b>	Verification bar	<input type="checkbox"/>
	Certified sphere for probing / scanning	<input checked="" type="checkbox"/>
<b>7-Axis kit</b>	7-Axis probing kit, installed	<input type="checkbox"/>
	AS1 kit, installed	<input type="checkbox"/>
	RS5 kit, installed	<input type="checkbox"/>
	RS-SQUARED kit, installed	<input type="checkbox"/>
	7-Axis SE kit, installed	<input type="checkbox"/>
<b>Warranty</b>	2 years**	<input checked="" type="checkbox"/>
<b>Certification</b>	ISO 10360-12 (certification for articulated arms for tactile measurement)	<input checked="" type="checkbox"/>
	ISO 10360-8 Annex D (certificate of combination for arm, laser scanner and area scanner)	<input checked="" type="checkbox"/>

\* All artefacts are delivered with a certification.

\*\* The warranty of two (2) years is valid only if an arm service check is performed during the first year.

# Absolute Arm 7-Axis 85 series

7-axis portable measuring arm for all-purpose tactile measurement and scanning functionality, including:

- Zero-G Counterbalance
- SmartLock + HomeDock
- Base plate
- TKJ 3-mm / 6-mm / 15-mm ball probes
- RDS calibration and interface software
- Wrist display
- Travel case
- Certified alignment sphere for probing/scanning
- ISO 10360-12 certification (for articulated arms for tactile measurement)
- 24-month warranty

- H00008000-03-8520 **Absolute Arm 8520-7**  
2.0 m measurement volume
- H00008000-03-8525 **Absolute Arm 8525-7**  
2.5 m measurement volume
- H00008000-03-8530 **Absolute Arm 8530-7**  
3.0 m measurement volume
- H00008000-03-8535 **Absolute Arm 8535-7**  
3.5 m measurement volume
- H00008000-03-8540 **Absolute Arm 8540-7**  
4.0 m measurement volume
- H00008000-03-8545 **Absolute Arm 8545-7**  
4.5 m measurement volume



<b>Encoder</b>	Absolute Encoders	<input checked="" type="checkbox"/>
<b>Measurement and security</b>	Zero-G Counterbalance   SmartLock   Home-Dock	<input checked="" type="checkbox"/>
<b>Display</b>	OLED wrist display   LED pictograms	<input checked="" type="checkbox"/>
<b>Haptic feedback</b>	Wrist vibration	<input checked="" type="checkbox"/>
<b>Handling grips</b>	SpinGrip*   SpinKnob	<input checked="" type="checkbox"/>
<b>Cables</b>	3-metre ethernet cable   Gigabit ethernet adaptor   Power supply	<input checked="" type="checkbox"/>
<b>Mounting base</b>	Standard base plate with mounting ring	<input checked="" type="checkbox"/>
<b>Probes</b>	TKJ L 50 – ø 15-mm stainless steel TKJ L 50 – ø 6-mm ruby TKJ L 50 – ø 3-mm ruby	<input checked="" type="checkbox"/> <input checked="" type="checkbox"/> <input checked="" type="checkbox"/>
<b>Packaging</b>	Hard case Accessories case	<input checked="" type="checkbox"/> <input checked="" type="checkbox"/>
<b>Dust cover</b>	Dust cover, Hexagon-branded	<input checked="" type="checkbox"/>

<b>Software</b>	USB Standard Package: RDS driver and interface User manuals	<input checked="" type="checkbox"/> <input checked="" type="checkbox"/>
<b>Control Pack</b>	Connector pack (CP-C) Wireless pack (CP-W)	<input type="checkbox"/> <input type="checkbox"/>
<b>Artefact**</b>	Verification bar Certified sphere for probing / scanning	<input checked="" type="checkbox"/> <input checked="" type="checkbox"/>
<b>7-Axis kit</b>	7-Axis probing kit, installed AS1 kit, installed RS5 kit, installed RS-SQUARED kit, installed 7-Axis SE kit, installed	<input type="checkbox"/> <input type="checkbox"/> <input type="checkbox"/> <input type="checkbox"/> <input type="checkbox"/>
<b>Warranty</b>	2 years***	<input checked="" type="checkbox"/>
<b>Certification</b>	ISO 10360-12 (certification for articulated arms for tactile measurement) ISO 10360-8 Annex D (certificate of combination for arm, laser scanner and area scanner)	<input checked="" type="checkbox"/>

\* Not available for 8520 models.

\*\* All artefacts are delivered with a certification.

\*\*\* The warranty of two (2) years is valid only if an arm service check is performed during the first year.

# Absolute Arm 7-Axis 87 series

7-axis portable measuring arm for all-purpose tactile measurement and scanning functionality, including:

- Zero-G Counterbalance
- SmartLock + HomeDock
- Base plate
- TKJ 3-mm / 6-mm / 15-mm ball probes
- RDS calibration and interface software
- Wrist display
- Travel case
- Certified alignment sphere for probing/scanning
- ISO 10360-12 certification (for articulated arms for tactile measurement)
- 24-month warranty

H00008000-03-8725	<b>Absolute Arm 8725-7</b> 2.5 m measurement volume
H00008000-03-8730	<b>Absolute Arm 8730-7</b> 3.0 m measurement volume
H00008000-03-8735	<b>Absolute Arm 8735-7</b> 3.5 m measurement volume
H00008000-03-8740	<b>Absolute Arm 8740-7</b> 4.0 m measurement volume
H00008000-03-8745	<b>Absolute Arm 8745-7</b> 4.5 m measurement volume



<b>Encoder</b>	Absolute Encoders	<input checked="" type="checkbox"/>
<b>Movement and security</b>	Zero-G Counterbalance   SmartLock   Home-Dock	<input checked="" type="checkbox"/>
<b>Display</b>	OLED wrist display   LED pictograms	<input checked="" type="checkbox"/>
<b>Haptic feedback</b>	Wrist vibration	<input checked="" type="checkbox"/>
<b>Handling grips</b>	SpinGrip   SpinKnob	<input checked="" type="checkbox"/>
<b>Cables</b>	3-metre ethernet cable   Gigabit ethernet adaptor   Power supply	<input checked="" type="checkbox"/>
<b>Mounting base</b>	Standard base plate with mounting ring	<input checked="" type="checkbox"/>
<b>Probes</b>	TKJ L 50 – ø 15-mm stainless steel TKJ L 50 – ø 6-mm ruby TKJ L 50 – ø 3-mm ruby	<input checked="" type="checkbox"/> <input checked="" type="checkbox"/> <input checked="" type="checkbox"/>
<b>Packaging</b>	Hard case Accessories case	<input checked="" type="checkbox"/> <input checked="" type="checkbox"/>
<b>Dust cover</b>	Dust cover, Hexagon-branded	<input checked="" type="checkbox"/>

<b>Software</b>	USB Standard Package: RDS driver and interface User manuals	<input checked="" type="checkbox"/> <input checked="" type="checkbox"/>
<b>Control Pack</b>	Connector pack (CP-C) Wireless pack (CP-W)	<input checked="" type="checkbox"/>
<b>Artefacts*</b>	Verification bar Certified sphere for probing / scanning	<input checked="" type="checkbox"/> <input checked="" type="checkbox"/>
<b>7-Axis kit</b>	7-Axis probing kit, installed AS1 kit, installed RS5 kit, installed RS-SQUARED kit, installed 7-Axis SE kit, installed	<input type="checkbox"/> <input type="checkbox"/> <input type="checkbox"/> <input type="checkbox"/> <input type="checkbox"/>
<b>Warranty</b>	2 years**	<input checked="" type="checkbox"/>
<b>Certification</b>	ISO 10360-12 (certification for articulated arms for tactile measurement) ISO 10360-8 Annex D (certificate of combination for arm, laser scanner and area scanner)	<input checked="" type="checkbox"/>

\* All artefacts are delivered with a certification.

\*\* The warranty of two (2) years is valid only if an arm service check is performed during the first year.

# Absolute Arm 6-Axis 83 series

6-axis portable measuring arm, designed for all-purpose tactile measurement or optional entry-level laser scanning, including:

- Zero-G Counterbalance
- SmartLock + HomeDock
- Base plate
- TKJ 3-mm / 6-mm / 15-mm ball probes
- RDS calibration and interface software
- Travel case
- Certified alignment sphere for probing
- ISO 10360-12 certification (for articulated arms for tactile measurement)
- 24-month warranty

- H00008000-01-8320 **Absolute Arm 8320-6**  
2.0 m measurement volume
- H00008000-01-8325 **Absolute Arm 8325-6**  
2.5 m measurement volume
- H00008000-01-8330 **Absolute Arm 8330-6**  
3.0 m measurement volume
- H00008000-01-8335 **Absolute Arm 8335-6**  
3.5 m measurement volume
- H00008000-01-8340 **Absolute Arm 8340-6**  
4.0 m measurement volume
- H00008000-01-8345 **Absolute Arm 8345-6**  
4.5 m measurement volume



<b>Encoder</b>	Absolute Encoders	<input checked="" type="checkbox"/>
<b>Movement and security</b>	Zero-G Counterbalance   SmartLock   Home-Dock	<input checked="" type="checkbox"/>
<b>Display</b>	LED pictograms	<input checked="" type="checkbox"/>
<b>Haptic feedback</b>	Wrist vibration	<input checked="" type="checkbox"/>
<b>Cables</b>	3-metre ethernet cable   Gigabit ethernet adaptor   Power supply	<input checked="" type="checkbox"/>
<b>Mounting base</b>	Standard base plate with mounting ring	<input checked="" type="checkbox"/>
<b>Probes</b>	TKJ L 50 – ø 15-mm stainless steel TKJ L 50 – ø 6-mm ruby TKJ L 50 – ø 3-mm ruby	<input checked="" type="checkbox"/> <input checked="" type="checkbox"/> <input checked="" type="checkbox"/>
<b>Packaging</b>	Hard case Accessories case	<input checked="" type="checkbox"/> <input checked="" type="checkbox"/>

<b>Dust cover</b>	Dust cover, Hexagon-branded	<input checked="" type="checkbox"/>
<b>Software</b>	USB Standard Package: RDS driver and interface User manuals	<input checked="" type="checkbox"/> <input checked="" type="checkbox"/>
<b>Control Pack</b>	Connector pack (CP-C) Wireless pack (CP-W)	<input type="checkbox"/> <input type="checkbox"/>
<b>Artefact*</b>	Verification bar Certified sphere for probing	opt <input checked="" type="checkbox"/>
<b>Warranty</b>	2 years**	<input checked="" type="checkbox"/>
<b>Certification</b>	ISO 10360-12 (certification for articulated arms for tactile measurement)	<input checked="" type="checkbox"/>

\* All artefacts are delivered with a certification.

\*\* The warranty of two (2) years is valid only if an arm service check is performed during the first year.



# Absolute Arm 6-Axis 85 series

6-axis portable measuring arm, designed for all-purpose tactile measurement or optional entry-level laser scanning, including:

- Zero-G Counterbalance
- SmartLock + HomeDock
- Base plate
- TKJ 3-mm / 6-mm / 15-mm ball probes
- RDS calibration and interface software
- Travel case
- Certified alignment sphere for probing
- ISO 10360-12 certification (for articulated arms for tactile measurement)
- 24-month warranty

H00008000-01-8520	<b>Absolute Arm 8520-6</b> 2.0 m measurement volume
H00008000-01-8525	<b>Absolute Arm 8525-6</b> 2.5 m measurement volume
H00008000-01-8530	<b>Absolute Arm 8530-6</b> 3.0 m measurement volume
H00008000-01-8535	<b>Absolute Arm 8535-6</b> 3.5 m measurement volume
H00008000-01-8540	<b>Absolute Arm 8540-6</b> 4.0 m measurement volume
H00008000-01-8545	<b>Absolute Arm 8545-6</b> 4.5 m measurement volume



<b>Encoder</b>	Absolute Encoders	<input checked="" type="checkbox"/>
<b>Movement and security</b>	Zero-G Counterbalance   SmartLock   Home-Dock	<input checked="" type="checkbox"/>
<b>Display</b>	LED pictograms	<input checked="" type="checkbox"/>
<b>Haptic feedback</b>	Wrist vibration	<input checked="" type="checkbox"/>
<b>Handling grips</b>	SpinGrip*   SpinKnob	<input checked="" type="checkbox"/>
<b>Cables</b>	3-metre ethernet cable   Gigabit ethernet adaptor   Power supply	<input checked="" type="checkbox"/>
<b>Mounting base</b>	Standard base plate with mounting ring	<input checked="" type="checkbox"/>
<b>Probes</b>	TKJ L 50 – ø 15-mm stainless steel TKJ L 50 – ø 6-mm ruby TKJ L 50 – ø 3-mm ruby	<input checked="" type="checkbox"/> <input checked="" type="checkbox"/> <input checked="" type="checkbox"/>

<b>Packaging</b>	Hard case Accessories case	<input checked="" type="checkbox"/> <input checked="" type="checkbox"/>
<b>Dust cover</b>	Dust cover, Hexagon-branded	<input checked="" type="checkbox"/>
<b>Software</b>	USB Standard Package: RDS driver and interface User manuals	<input checked="" type="checkbox"/> <input checked="" type="checkbox"/>
<b>Control Pack</b>	Connector pack (CP-C) Wireless pack (CP-W)	<input type="checkbox"/> <input type="checkbox"/>
<b>Artefact**</b>	Verification bar Certified sphere for probing	<input checked="" type="checkbox"/> <input checked="" type="checkbox"/>
<b>Warranty</b>	2 years***	<input checked="" type="checkbox"/>
<b>Certification</b>	ISO 10360-12 (certification for articulated arms for tactile measurement)	<input checked="" type="checkbox"/>

\* Not available for 8520 models.

\*\* All artefacts are delivered with a certification.

\*\*\* The warranty of two (2) years is valid only if an arm service check is performed during the first year.

# Absolute Arm 6-Axis 87 series

6-axis portable measuring arm, designed for all-purpose tactile measurement or optional entry-level laser scanning, including:

- Zero-G Counterbalance
- SmartLock + HomeDock
- Base plate
- TKJ 3-mm / 6-mm / 15-mm ball probes
- RDS calibration and interface software
- Travel case
- Certified alignment sphere for probing
- ISO 10360-12 certification (for articulated arms for tactile measurement)
- 24-month warranty

- H00008000-01-8725 **Absolute Arm 8725-6**  
2.5 m measurement volume
- H00008000-01-8730 **Absolute Arm 8730-6**  
3.0 m measurement volume
- H00008000-01-8735 **Absolute Arm 8735-6**  
3.5 m measurement volume
- H00008000-01-8740 **Absolute Arm 8740-6**  
4.0 m measurement volume
- H00008000-01-8745 **Absolute Arm 8745-6**  
4.5 m measurement volume



<b>Encoder</b>	Absolute Encoders	<input checked="" type="checkbox"/>
<b>Movement and security</b>	Zero-G Counterbalance   SmartLock   Home-Dock	<input checked="" type="checkbox"/>
<b>Display</b>	LED pictograms	<input checked="" type="checkbox"/>
<b>Haptic feedback</b>	Wrist vibration	<input checked="" type="checkbox"/>
<b>Handling grips</b>	SpinGrip   SpinKnob	<input checked="" type="checkbox"/>
<b>Cables</b>	3-metre ethernet cable   Gigabit ethernet adaptor   Power supply	<input checked="" type="checkbox"/>
<b>Mounting base</b>	Standard base plate with mounting ring	<input checked="" type="checkbox"/>
<b>Probes</b>	TKJ L 50 – ø 15-mm stainless steel	<input checked="" type="checkbox"/>
	TKJ L 50 – ø 6-mm ruby	<input checked="" type="checkbox"/>
	TKJ L 50 – ø 3-mm ruby	<input checked="" type="checkbox"/>

<b>Packaging</b>	Hard case	<input checked="" type="checkbox"/>
	Accessories case	<input checked="" type="checkbox"/>
<b>Dust cover</b>	Dust cover, Hexagon-branded	<input checked="" type="checkbox"/>
<b>Software</b>	USB Standard Package: RDS driver and interface User manuals	<input checked="" type="checkbox"/>
<b>Control Pack</b>	Connector pack (CP-C) Wireless pack (CP-W)	<input checked="" type="checkbox"/>
<b>Artefact*</b>	Verification bar	<input checked="" type="checkbox"/>
	Certified sphere for probing	<input checked="" type="checkbox"/>
<b>Warranty</b>	2 years**	<input checked="" type="checkbox"/>
<b>Certification</b>	ISO 10360-12 (certification for articulated arms for tactile measurement)	<input checked="" type="checkbox"/>

\* All artefacts are delivered with a certification.

\*\* The warranty of two (2) years is valid only if an arm service check is performed during the first year.

# Absolute Arm Compact

Versatile 6-axis small-diameter ultra-high-accuracy portable measuring arm, including:

- Integrated base
- Counterweight balance system
- TKJ 3-mm / 6-mm / 15-mm ball probes
- RDS calibration and interface software
- Travel case
- 3 magnetic anchors
- Certified alignment sphere for probing
- ISO 10360-12\*\*\*\* alignment (for articulated arms for tactile measurement)
- 24-month warranty

H00008000-01-8312 **Absolute Arm 8312-6**  
1.2 m measurement volume

H00008000-01-8512 **Absolute Arm 8512-6**  
1.2 m measurement volume



<b>Encoder</b>	Absolute Encoders	<input checked="" type="checkbox"/>
<b>Haptic feedback</b>	Wrist vibration	<input checked="" type="checkbox"/>
<b>Display</b>	LED pictograms	<input checked="" type="checkbox"/>
<b>Handling grips</b>	SpinKnob*	<input checked="" type="checkbox"/>
<b>Cables</b>	3-metre ethernet cable   Gigabit ethernet adaptor   Power supply	<input checked="" type="checkbox"/>
<b>Mounting base</b>	Standard base plate Magnetic anchors	<input checked="" type="checkbox"/> <input checked="" type="checkbox"/>
<b>Probes</b>	TKJ L 50 – ø 15-mm stainless steel TKJ L 50 – ø 6-mm ruby TKJ L 50 – ø 3-mm ruby	<input checked="" type="checkbox"/> <input checked="" type="checkbox"/> <input checked="" type="checkbox"/>
<b>Packaging</b>	Hard case Accessories case	<input checked="" type="checkbox"/> <input checked="" type="checkbox"/>

<b>Dust cover</b>	Dust cover, Hexagon-branded	<input checked="" type="checkbox"/>
<b>Software</b>	USB Standard Package: RDS driver and interface User manuals	<input checked="" type="checkbox"/> <input checked="" type="checkbox"/>
<b>Control Pack</b>	Connector pack (CP-C) Wireless pack (CP-W)	<input type="checkbox"/> <input type="checkbox"/>
<b>Artefact**</b>	Verification bar (83 series) Verification bar (85 series) Certified sphere for probing	opt <input checked="" type="checkbox"/> <input checked="" type="checkbox"/>
<b>Warranty</b>	2 years***	<input checked="" type="checkbox"/>
<b>Certification</b>	ISO 10360-12 (certification for articulated arms for tactile measurement) ISO 10360-02 (certification for use in conjunction with a full-size CMM)****	<input checked="" type="checkbox"/> opt

\* 85 Series only.

\*\* All artefacts are delivered with a certification.

\*\*\* The warranty of two (2) years is valid only if an arm service check is performed during the first year.

\*\*\*\* Optional certification.



# Absolute Arm Tube

6-axis portable measuring arm designed for tube measurement, with a special counterbalance, including:

- Zero-G Counterbalance, tube version
- SmartLock + HomeDock
- Base plate
- TKJ 3-mm / 6-mm / 15-mm ball probes
- RDS calibration and interface software
- Travel case
- Certified alignment sphere for probing
- ISO 10360-12 certification (for articulated arms for tactile measurement)
- 24-month warranty

H00008000-02-8325 **Absolute Arm 8325 T**  
2.5 m measurement volume

H00008000-02-8330 **Absolute Arm 8330 T**  
3.0 m measurement volume



<b>Encoder</b>	Absolute Encoders	<input checked="" type="checkbox"/>
<b>Movement and security</b>	Zero-G Counterbalance   SmartLock   Home-Dock	<input checked="" type="checkbox"/>
<b>Haptic feedback</b>	Wrist vibration	<input checked="" type="checkbox"/>
<b>Cables</b>	3-metre ethernet cable   Gigabit ethernet adaptor   Power supply	<input checked="" type="checkbox"/>
<b>Mounting base</b>	Standard base plate with mounting ring	<input checked="" type="checkbox"/>
<b>Probes</b>	TKJ L 50 – ø 15-mm stainless steel	<input checked="" type="checkbox"/>
	TKJ L 50 – ø 6-mm ruby	<input checked="" type="checkbox"/>
	TKJ L 50 – ø 3-mm ruby	<input checked="" type="checkbox"/>
<b>Packaging</b>	Hard case	<input checked="" type="checkbox"/>
	Accessories case	<input checked="" type="checkbox"/>

<b>Dust cover</b>	Dust cover, Hexagon-branded	<input checked="" type="checkbox"/>
<b>Software</b>	USB Standard Package: RDS driver and interface User manuals	<input checked="" type="checkbox"/> <input checked="" type="checkbox"/>
<b>Control Pack</b>	Connector pack (CP-C) Wireless pack (CP-W)	<input type="checkbox"/> <input type="checkbox"/>
<b>Artefact*</b>	Verification bar Certified sphere for probing	opt <input checked="" type="checkbox"/>
<b>Warranty</b>	2 years**	<input checked="" type="checkbox"/>
<b>Certification</b>	ISO 10360-12 (certification for articulated arms for tactile measurement)	<input checked="" type="checkbox"/>

\* All artefacts are delivered with a certification.

\*\* The warranty of two (2) years is valid only if an arm service check is performed during the first year.



# Probes and scanners

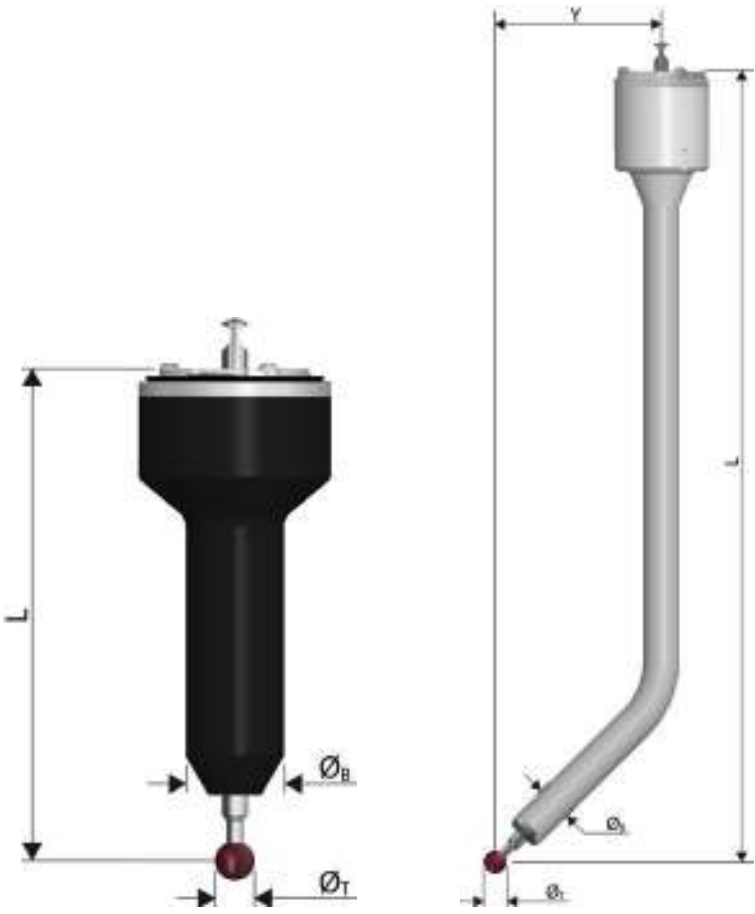

- TKJ aluminium-body contact probes 24
- TKJ carbon-body contact probes 26
- TKJ angled contact probes 30
- TKJ contact probe kits 31
- TKJ special probes 32
- TKJ touch trigger probes 33
- M3 styli 34
- Non-contact tube probes 35
- Scanners 36

# TKJ aluminium-body contact probes

Standard aluminium probes for the Absolute Arm are available from 50 to 100 millimetres in length. An M3 connector allows the use of any M3 sphere tip.

8x12	✓
83-6 / 85-6 / 87-6	✓
83-7 / 85-7 / 87-7	✓

		<i>L</i>	<i>Body</i>	$\varnothing_B$	<i>Tip type</i>	<i>Tip material</i>	$\varnothing_T$	
H00007186*	<b>Probe with fixed ball (SS-15-SS-50)</b>	50 mm	Stainless steel	15 mm	Fixed ball	Stainless steel	15 mm	
H00007189-50*	<b>Probe with M3-stylus (R-3-A-50)</b>	50 mm	Aluminium	15 mm	M3	Synth. ruby	3 mm	
H00007187-50*	<b>Probe with M3-stylus (R-6-A-50)</b>	50 mm	Aluminium	15 mm	M3	Synth. ruby	6 mm	
H00007189-75	<b>Probe with M3-stylus (R-3-A-75)</b>	75 mm	Aluminium	15 mm	M3	Synth. ruby	3 mm	
H00007187-75	<b>Probe with M3-stylus (R-6-A-75)</b>	75 mm	Aluminium	15 mm	M3	Synth. ruby	6 mm	
H00007189-100	<b>Probe with M3-stylus (R-3-A-100)</b>	100 mm	Aluminium	15 mm	M3	Synth. ruby	3 mm	
H00007187-100	<b>Probe with M3-stylus (R-6-A-100)</b>	100 mm	Aluminium	15 mm	M3	Synth. ruby	6 mm	

\* Already included as standard probes within all Absolute Arm packages.



# TKJ aluminium-body contact probes









		<i>L</i>	<i>Body</i>	$\varnothing_B$	<i>Tip type</i>	<i>Tip material</i>	$\varnothing_T$
54388-03	<b>Probe with M3-pointer stylus (A-50)</b>	50 mm	Aluminium	15 mm	M3	Tungsten carbide	Point
54388-11	<b>Probe with M3-stylus (CE-12.7-A-50)</b>	50 mm	Aluminium	15 mm	Fixed ball	Ceramic	12.7 mm
H00000906-01	<b>Probe with fixed ball (SS-9.5-SS-50)</b>	50 mm	Stainless steel	15 mm	Fixed ball	Stainless steel	9.5 mm
54388-06	<b>Probe with M3-Pointer stylus (A-75)</b>	75 mm	Aluminium	15 mm	M3	Tungsten carbide	Point
54388-09	<b>Probe with M3-Pointer stylus (A-100)</b>	100 mm	Aluminium	15 mm	M3	Tungsten carbide	Point



# TKJ carbon-body contact probes

Carbon-body probes for the Absolute Arm offer the largest range of probe sizes and types. Models available from 50 to 350 millimetres in length, and with standard M3 ball tips or fixed balls from 2 to 25 millimetres in diameter, for any kind of hard-contact probing task.

8x12	✓
83-6 / 85-6 / 87-6	✓
83-7 / 85-7 / 87-7	✓

		<i>L</i>	<i>Body</i>	$\varnothing_B$	<i>Tip type</i>	<i>Tip material</i>	$\varnothing_T$	
H00000383-01	<b>Probe with fixed ball (SS-9.5-C-50)</b>	50 mm	Carbon fibre	16 mm	Fixed ball	Stainless steel	9.5 mm	
H00000383-02	<b>Probe with fixed ball (SS-10-C-50)</b>	50 mm	Carbon fibre	16 mm	Fixed ball	Stainless steel	10 mm	
H00000383-03	<b>Probe with fixed ball (SS-15-C-50)</b>	50 mm	Carbon fibre	16 mm	Fixed ball	Stainless steel	15 mm	
H00000383-04	<b>Probe with fixed ball (SS-10-C-75)</b>	75 mm	Carbon fibre	16 mm	Fixed ball	Stainless steel	10 mm	
H00000383-05	<b>Probe with fixed ball (SS-15-C-75)</b>	75 mm	Carbon fibre	16 mm	Fixed ball	Stainless steel	15 mm	
H00000383-06	<b>Probe with fixed ball (SS-9.525-C-82)</b>	82 mm	Carbon fibre	16 mm	Fixed ball	Stainless steel	9.5 mm	
H00000383-07	<b>Probe with fixed ball (SS-12.7-C-85)</b>	85 mm	Carbon fibre	16 mm	Fixed ball	Stainless steel	12.7 mm	
H00000383-09	<b>Probe with fixed ball (SS-25-C-85)</b>	85 mm	Carbon fibre	16 mm	Fixed ball	Stainless steel	25 mm	
H00000576-01	<b>Probe with M3-stylus (R-2-C-85)</b>	85 mm	Carbon fibre	16 mm	M3	Synth. ruby	2 mm	
54397-01	<b>Probe with M3-stylus (R-3-C-85)</b>	85 mm	Carbon fibre	16 mm	M3	Synth. ruby	3 mm	
H00000576-02	<b>Probe with M3-stylus (R-4-C-85)</b>	85 mm	Carbon fibre	16 mm	M3	Synth. ruby	4 mm	
54397-02	<b>Probe with M3-stylus (R-6-C-85)</b>	85 mm	Carbon fibre	16 mm	M3	Synth. ruby	6 mm	
54397-03	<b>Probe with M3-pointer (C-85)</b>	85 mm	Carbon fibre	16 mm	M3	Tungsten carbide	Point	

# TKJ carbon-body contact probes

		<i>L</i>	<i>Body</i>	$\varnothing_B$	<i>Tip type</i>	<i>Tip material</i>	$\varnothing_T$	
H00000576-04	<b>Probe with M3-stylus (R-10-C-100)</b>	100 mm	Carbon fibre	16 mm	M3	Synth. ruby	10 mm	
H00000576-03	<b>Probe with M3-stylus (R-2-C-100)</b>	100 mm	Carbon fibre	16 mm	M3	Synth. ruby	2 mm	
54397-04	<b>Probe with M3-stylus (R-3-C-100)</b>	100 mm	Carbon fibre	16 mm	M3	Synth. ruby	3 mm	
54397-05	<b>Probe with M3-stylus (R-6-C-100)</b>	100 mm	Carbon fibre	16 mm	M3	Synth. ruby	6 mm	
54397-06	<b>Probe with M3-pointer (C-100)</b>	100 mm	Carbon fibre	16 mm	M3	Tungsten carbide	Point	
H00000383-10	<b>Probe with fixed ball (SS-10-C-130)</b>	130 mm	Carbon fibre	16 mm	Fixed ball	Stainless steel	10 mm	
H00000383-11	<b>Probe with fixed ball (SS-15-C-130)</b>	130 mm	Carbon fibre	16 mm	Fixed ball	Stainless steel	15 mm	
54397-07	<b>Probe with M3-stylus (R-3-C-130)</b>	130 mm	Carbon fibre	16 mm	M3	Synth. ruby	3 mm	
H00000576-05	<b>Probe with M3-stylus (R-4-C-130)</b>	130 mm	Carbon fibre	16 mm	M3	Synth. ruby	4 mm	
54397-08	<b>Probe with M3-stylus (R-6-C-130)</b>	130 mm	Carbon fibre	16 mm	M3	Synth. ruby	6 mm	
54397-09	<b>Probe with M3-pointer (C-130)</b>	130 mm	Carbon fibre	16 mm	M3	Tungsten carbide	Point	
H00000383-12	<b>Probe with fixed ball (SS-10-C-150)</b>	150 mm	Carbon fibre	16 mm	Fixed ball	Stainless steel	10 mm	
H00000383-13	<b>Probe with fixed ball (SS-15-C-150)</b>	150 mm	Carbon fibre	16 mm	Fixed ball	Stainless steel	15 mm	

# TKJ carbon-body contact probes

		<i>L</i>	<i>Body</i>	$\varnothing_B$	<i>Tip type</i>	<i>Tip material</i>	$\varnothing_T$	
H00000576-06	<b>Probe with M3-stylus (R-2-C-150)</b>	150 mm	Carbon fibre	16 mm	M3	Synth. ruby	2 mm	
54397-10	<b>Probe with M3-stylus (R-3-C-150)</b>	150 mm	Carbon fibre	16 mm	M3	Synth. ruby	3 mm	
54397-11	<b>Probe with M3-stylus (R-6-C-150)</b>	150 mm	Carbon fibre	16 mm	M3	Synth. ruby	6 mm	
54397-12	<b>Probe with M3-pointer (C-150)</b>	150 mm	Carbon fibre	16 mm	M3	Tungsten carbide	Point	
H00000383-14	<b>Probe with fixed ball (SS-15-C-165)</b>	165 mm	Carbon fibre	16 mm	Fixed Ball	Stainless steel	15 mm	
H00000383-15	<b>Probe with fixed ball (SS-10-C-180)</b>	180 mm	Carbon fibre	16 mm	Fixed Ball	Stainless steel	10 mm	
H00000383-16	<b>Probe with fixed ball (SS-15-C-180)</b>	180 mm	Carbon fibre	16 mm	Fixed Ball	Stainless steel	15 mm	
H00000383-17	<b>Probe with fixed ball (SS-20-C-180)</b>	180 mm	Carbon fibre	16 mm	Fixed Ball	Stainless steel	20 mm	
54397-13	<b>Probe with M3-stylus (R-3-C-180)</b>	180 mm	Carbon fibre	16 mm	M3	Synth. ruby	3 mm	
54397-14	<b>Probe with M3-stylus (R-6-C-180)</b>	180 mm	Carbon fibre	16 mm	M3	Synth. ruby	6 mm	
54397-15	<b>Probe with M3-pointer (C-180)</b>	180 mm	Carbon fibre	16 mm	M3	Tungsten carbide	Point	
54397-16	<b>Probe with M3-stylus (R-3-C-200)</b>	200 mm	Carbon fibre	16 mm	M3	Synth. ruby	3 mm	
54397-18	<b>Probe with M3-pointer (C-200)</b>	200 mm	Carbon fibre	16 mm	M3	Tungsten carbide	Point	

# TKJ carbon-body contact probes

		<i>L</i>	<i>Body</i>	$\varnothing_B$	<i>Tip type</i>	<i>Tip material</i>	$\varnothing_T$
H00000383-18	<b>Probe with fixed ball (SS-15-C-293)</b>	293 mm	Carbon fibre	16 mm	Fixed ball	Stainless steel	15 mm
H00000576-10	<b>Probe with M3-stylus (R-3-C-300)</b>	300 mm	Carbon fibre	16 mm	M3	Synth. ruby	3 mm
H00000576-08	<b>Probe with M3-stylus (R-6-C-350)</b>	350 mm	Carbon fibre	16 mm	M3	Synth. ruby	6 mm



# TKJ angled contact probes

For hard-to-reach areas of parts, the Absolute Arm can be equipped with special angled probes designed to allow for measuring around obstacles. Angles of 45, 60 and 90 degrees are available.

8x12	✓
83-6 / 85-6 / 87-6	✓
83-7 / 85-7 / 87-7	✓

		L	Y	Body	Tip type	Tip material	$\varnothing_T$	
54280-01	Angle Probe 45DEG with M3-Pointer Stylus (TC-10)	149 mm	38 mm	Aluminium	M3	Tungsten carbide	Point	
54280-02	Angle Probe 45DEG with M3-Stylus (R-3-SS-1.5-L10)	149 mm	38 mm	Aluminium	M3	Synth. ruby	3 mm	
54280-03	Angle Probe 45DEG with M3-Stylus (R-4-SS-2.5-L10)	149 mm	38 mm	Aluminium	M3	Synth. ruby	4 mm	
54280-04	Angle Probe 45DEG with M3-Stylus (R-6-SS-2.7-L10)	149 mm	38 mm	Aluminium	M3	Synth. ruby	6 mm	
54280-05	Angle Probe 60DEG with M3-Pointer Stylus (TC-L10)	149 mm	57 mm	Aluminium	M3	Tungsten carbide	Point	
54280-06	Angle Probe 60DEG with M3-Stylus (R-3-SS-1.5-L10)	149 mm	57 mm	Aluminium	M3	Synth. ruby	3 mm	
54280-07	Angle Probe 60DEG with M3-Stylus (R-4-SS-2.5-L10)	149 mm	57 mm	Aluminium	M3	Synth. ruby	4 mm	
54280-08	Angle Probe 60DEG with M3-Stylus (R-6-SS-2.7-L10)	149 mm	57 mm	Aluminium	M3	Synth. ruby	6 mm	
54280-09	Angle Probe 90DEG with M3-Pointer Stylus (TC-L10)	173 mm	43 mm	Aluminium	M3	Tungsten carbide	Point	
54280-10	Angle Probe 90DEG with M3-Stylus (R-3-SS-1.5-L10)	173 mm	43 mm	Aluminium	M3	Synth. ruby	3 mm	
54280-11	Angle Probe 90DEG with M3-Stylus (R-4-SS-2.5-L10)	173 mm	43 mm	Aluminium	M3	Synth. ruby	4 mm	
54280-12	Angle Probe 90DEG with M3-Stylus (R-6-SS-2.7-L10)	173 mm	43 mm	Aluminium	M3	Synth. ruby	6 mm	

# TKJ contact probe kits

To enhance the possibilities of probing, customisable probe kits are available, each offering a different range of probe sizes.

8x12	✓
83-6 / 85-6 / 87-6	✓
83-7 / 85-7 / 87-7	✓

54388-50B

**Probe Body (Aluminium / L=50 mm)**

Individual solid aluminum probe shaft, length 50 millimetres.  
For use with all Absolute Arm models with a TESA kinematic joint connector.



54388-100B

**Probe Body (Aluminium / L=100 mm)**

Individual solid aluminum probe shaft, length 100 millimetres.  
For use with all Absolute Arm models with a TESA kinematic joint connector.



54135

**Probe Kit – Short body (Aluminium)**

Short-body probe set consisting of 5 aluminium probe shafts, 5 styli with ruby-ball tips, 2 adaptors and tools.  
For use with all Absolute Arm models with a TESA kinematic joint connector.

Bodies (Aluminium)	Length	50 mm / 60 mm / 70 mm / 85 mm / 100 mm
Tips (Synth. ruby)	∅	2 mm / 3 mm / 4 mm / 5 mm / 6 mm
	Length	10 mm
Connectors		2 x TKJ
Tools		Body probe wrench + probe pin wrench



54136

**Probe Kit – Long body (Aluminium)**

Long-body probe set consisting of 4 carbon-fibre probe shafts, 5 styli with ruby-ball tips, 2 adaptors and tools.  
For use with all Absolute Arm models with a TESA kinematic joint connector.

Bodies (Carbon fiber)	Length	130 mm / 150 mm / 180 mm / 200 mm
Tips (Synth. ruby)	∅	2 mm / 3 mm / 4 mm / 5 mm / 6 mm
	Length	10 mm
Connectors		2 x TKJ
Tools		Body probe wrench + tip wrench



# TKJ special contact probes

Probes to designed to seat spherical retroreflectors or for customised purposes.

8x12	✓
83-6 / 85-6 / 87-6	✓
83-7 / 85-7 / 87-7	✓

## H00000742-01 **Probe-Alu-L75-12.7 for Tracker**

Reflector not included.

$\varnothing$	Tip type	L	Body
12.7 mm	Magnetic seat	75 mm	Aluminium



## H00000742-02 **Probe-Alu-L75-22.225 for Tracker**

Reflector not included.

$\varnothing$	Tip type	L	Body
22.225 mm	Magnetic seat	75 mm	Aluminium



## H00000742-03 **Probe-Alu-L75-38.1 for Tracker**

Reflector not included.

$\varnothing$	Tip type	L	Body
38.1 mm	Magnetic seat	75 mm	Aluminium



## 54431 **Universal Probe Adaptor – TKJ male to M8**

Probe body for adapting any M8 standard or customised probe adaptor.





# TKJ touch-trigger probes

Touch-trigger probes allow for the measurement of sensitive parts. Available in fixed or adjustable versions, the touch-trigger probe is triggered immediately upon touching the surface. Suitable for any soft surface and for easily movable parts.

8x12	✓
83-6 / 85-6 / 87-6	✓
83-7 / 85-7 / 87-7	✓

34386

**HP-T-EF Touch-Trigger Probe Kit**  
TKJ male probe with touch-trigger contact.

TKJ-M8-TTP	<i>NCA7-5-19344 included</i>	
Tips (Synth. ruby)	ø	3 mm / 6 mm
	Length	20 mm / 10 mm
Trigger force	Extended force (0.10 N at 50mm)	
Length	73 mm	



NCA7-3-52596

**HP-T-RP M8 Adjustable Touch-Trigger Probe Head**  
M8 head for TKJ adaptor touch-trigger probe.

TKJ-M8-TTP	<i>NCA7-5-19344 included</i>	
Tips (Synth. ruby)	ø	3 mm / 6 mm
	Length	10 mm
Trigger force	Adjustable 0.11 N - 0.30 N	
Length	85 mm	



34385

**TP20 Renishaw Touch-Trigger Probe Kit**  
TKJ male probe with touch-trigger contact.

TKJ-M8-TTP	<i>NCA7-5-19344 included</i>	
Tips (Synth. ruby)	ø	3 mm / 6 mm
	Length	20 mm (ø 3 mm) / 10 mm (ø 6 mm)
Trigger Force	Extended force (0.1N at 50 mm) – 2 heads	
Length	83 mm	



NCA7-5-19344

**TTP Adaptor – M8**  
TKJ-M base for all M8 touch-trigger probe heads.



# M3 styli

A range of tips is available to allow for adapting the probe to the measurement object. All tips are fixed with a M3 thread and can be used on any hard-contact body probe or touch-trigger probe.

8x12	✓
83-6 / 85-6 / 87-6	✓
83-7 / 85-7 / 87-7	✓

		$\varnothing$	D	A	Tip material	L
74128	M3-Stylus (R-2-SS-1.5-L10)	2 mm	1.5 mm	M3	Synth. ruby	10 mm
74133	M3-Pointer Stylus (TC-L10)	Point	-	M3	Tungsten carbide	10 mm
03969327	M3-Stylus (R-3-SS-2-L10)	3 mm	2 mm	M3	Synth. ruby	10 mm
74130	M3-Stylus (R-4-SS-2.5-L10)	4 mm	2.5 mm	M3	Synth. ruby	10 mm
74131	M3-Stylus (R-5-SS-2.5-L10)	5 mm	2.5 mm	M3	Synth. ruby	10 mm
03969326	M3-Stylus (R-6-SS-2.5-L10)	6 mm	2.7 mm	M3	Synth. ruby	10 mm
NCA7-7-18998	M3-Stylus (R2-SS-1.5-L20)	2 mm	1.5 mm	M3	Synth. ruby	20 mm
NCA7-7-19997	M3-Stylus (R3-SS-2-L20)	3 mm	2 mm	M3	Synth. ruby	20 mm
NCA7-7-19998	M3-Stylus (R6-SS-2.5-L20)	6 mm	2.7 mm	M3	Synth. ruby	20 mm

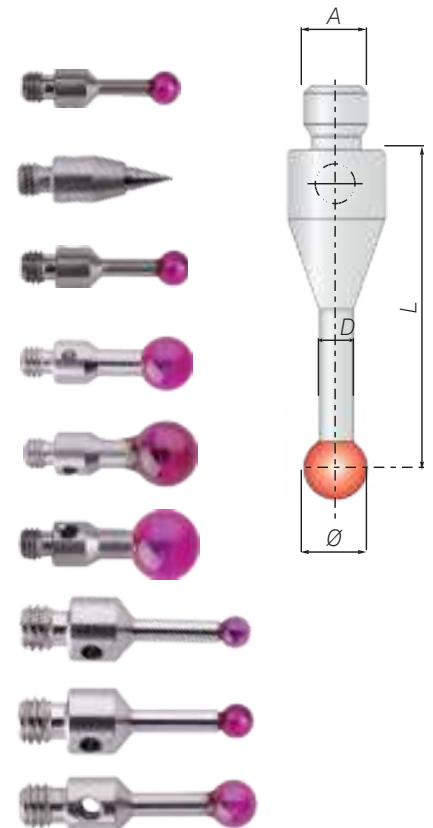

# Non-contact tube probes

Infrared non-contact probes for tube measurement are available in 6 sizes, allowing measurement of all kinds of tubes. A laser dot (class 2M) guides the user for precise placement. Compatible with TubeShaper, GTube and Docs software.

8x12	✓
83-6 / 85-6 / 87-6	✓
83-7 / 85-7 / 87-7	✓

**NCA7-2-21952-01 NCP1 Non-Contact Tube Probe (12.5 mm)**

∅	4-13 mm
Recommended T-bar*	∅ 6.4 mm (ref. NCA7-2-21953-01)
Recommended Z Gage*	∅ 8 mm (ref. NCA7-2-21954-01)

**NCA7-2-21952-02 NCP2 Non-Contact Tube Probe (25 mm)**

∅	6-20 mm
Recommended T-bar*	∅ 6.4 mm (ref. NCA7-2-21953-01)
Recommended Z Gage*	∅ 8 mm (ref. NCA7-2-21954-01)

**NCA7-2-21952-03 NCP3 Non-Contact Tube Probe (50 mm)**

∅	10-40 mm
Recommended T-bar*	∅ 12.7 mm (ref. NCA7-2-21953-02)
Recommended Z Gage*	∅ 20 mm (ref. NCA7-2-21954-02)

**NCA7-2-21952-04 NCP4 Non-Contact Tube Probe (75 mm)**

∅	12-65 mm
Recommended T-bar*	∅ 12.7 mm (ref. NCA7-2-21953-02)
Recommended Z Gage*	∅ 20 mm (ref. NCA7-2-21954-02)

**NCA7-2-21952-05 NCP5 Non-Contact Tube Probe (100 mm)**

∅	20-85 mm
Recommended T-bar*	∅ 25.4 mm (ref. NCA7-2-21953-03)
Recommended Z Gage*	∅ 40 mm (ref. NCA7-2-21954-03)

**NCA7-2-21952-06 NCP6 Non-Contact Tube Probe (150 mm)**

∅	30-130 mm
Recommended T-bar*	∅ 25.4 mm (ref. NCA7-2-21953-03)
Recommended Z Gage*	∅ 40 mm (ref. NCA7-2-21954-03)



\* Certified T-bar for alignment and certified Z Gage for verification not included.

# Absolute Scanner AS1 and RS-SQUARED Area Scanner

H00027250



## AS1 Kit, Accessory, for RA8 7-Axis

The Absolute Scanner AS1 is the flagship 3D scanning sensor for Absolute Tracker AT960 and Absolute Arm 7-Axis systems. Shipped individually in shipping box.

8x12	
83-6 / 85-6 / 87-6	
83-7 / 85-7 / 87-7	✓

### Includes

- Absolute Scanner AS1
- RDS maintenance and interface software
- Certified scanning sphere, incl. certificate
- Scanner certificate
- 2-year warranty\*

### Warning

Arm must be equipped with at least CP1 or CP-C.

Scanner not delivered with "System Scanning Accuracy" ISO 10360-8 Annex-D report.

ODU-ethernet cable (3 m) not included.

Gigabit ethernet adaptor not included.

Wireless scanning available only with CP-W.

H00013263



## RS-SQUARED kit, Accessory, for RA8 7-Axis

Ground-breaking white light scanner for RA8 Absolute Arm 7-Axis models. Shipped individually in shipping box.

### Includes

- RS-SQUARED Area Scanner
- RDS maintenance and interface software
- Rest cradle
- Artefact plate for alignment and calibration, incl. certificate
- Certificates
- Travel case and strap
- 2-year warranty\*

### Warning

Arm must be equipped with at least CP1 or CP-C.

Scanner not delivered with "System Scanning Accuracy" ISO 10360-8 Annex-D report.

ODU-ethernet cable (3 m) not included.

Ethernet gigabit adaptor not included.

Wireless scanning available only with CP-W.

RS-SQUARED can not be used with any 2-metre arm models.

\* The warranty of two (2) years is valid only if an arm service check is performed during the first year.

# RS5 and HP-L-8.9 Laser Scanners

H00007975

**RS5 Kit, Accessory, for RA8 7-Axis**  
 General purpose laser scanner for the RA8 Absolute Arm 7-Axis. Shipped individually in shipping box.

8x12	
83-6 / 85-6 / 87-6	
83-7 / 85-7 / 87-7	✓

- Includes*
- RS5 Laser Scanner
  - RDS maintenance and interface software
  - Certified scanning sphere, incl. certificate
  - Scanner certificate
  - 2-year warranty

*Warning*  
 Arm must be equipped with at least CP1 or CP-C.  
 Scanner not delivered with the "System Scanning Accuracy" ISO 10360-8 Annex-D report.  
 ODU-ethernet cable (3 m) not included.  
 Ethernet gigabit adaptor not included.  
 Wireless scanning available only with CP-W.



H00007977

**HP-L-8.9 Accessory Kit, for RA8 6-Axis**  
 Cost-effective laser scanner for the Absolute Arm 6-Axis. Shipped individually in shipping box.

- Includes*
- HP-L-8.9 Laser Scanner
  - Certified sphere for probing and scanning
  - ODU-ethernet cable (3 m)
  - Scanner certification
  - RDS maintenance and interface software
  - Travel case
  - 1-year warranty

*Warning*  
 Arm must be equipped with at least CP1 or CP-C.  
 Scanner not delivered with "System Scanning Accuracy" ISO 10360-8 Annex-D report.  
 Wireless scanning not available with HP-L-8.9.





# Mounting solutions

Standard bases **40**

Bases **41**

Tripods **42**

Stands **43**

Tables **44**

Raisers **45**

# Standard bases

All the standard bases for the Absolute Arm are designed for use with the Absolute Arm Mounting Ring.

NCA7-5-21497

## Base Plate with Mounting Ring

Base mounting set that can be used to fix a base plate to the Absolute Arm so that it can stand freely on any flat and stable surface. Fully compatible with accuracy specifications and all Absolute Arm models.

### Delivery contents

- Base plate (size: 170 x 235 x 15 mm)
- Mounting ring (ø 108 mm)
- 6 screws (SHCS, M8 x 1.25 x 25 SS)

8x12	✓*
83-6 / 85-6 / 87-6	✓
83-7 / 85-7 / 87-7	✓



NCA7-5-19866

## Magnetic Base with Mounting Ring

Magnetic mounting adaptor for magnetically fixing any Absolute Arm system to magnetic surfaces. Works best on flat surfaces. Fully compatible with accuracy specifications and all Absolute Arm models.

### Delivery contents

- Magnetic base plate (size: 238 x 271 x 112 mm)
- Set of three magnets (100 kg force / unit, size: 50 x 55 x 73 mm)
- Mounting ring (ø 108 mm)
- 3 screws (SHCS, M8 x 1.25 x 20 SS)
- 6 screws (SHCS, M8 x 1.25 x 25 SS)

8x12	✓*
83-6 / 85-6 / 87-6	✓
83-7 / 85-7 / 87-7	✓



H00008527

## Witte Vacuum Mount Base

For mounting the arm on any flat surface without additional tools. For arms with up to 2.5 m measurement volume. Weight 6.3 kg.

### Delivery contents

- Mounting ring
- Storage and transport case
- Rechargeable battery and charger
- User manual

8x12	✓*
83-6 / 85-6 / 87-6	✓
83-7 / 85-7 / 87-7	✓



NCA-7-7-19225

## Circular Magnetic Base

Magnetic circular base only, please order the mounting ring H00004220

8x12	✓*
83-6 / 85-6 / 87-6	✓
83-7 / 85-7 / 87-7	✓



\* For 8x12 models a Mounting Ring Adaptor (H00012888) is required.



# Bases

H00004220

## Mounting Ring

Ring attachment that allows the Absolute Arm to be mounted to any surface using just 6 screws, with no additional base plate required.

Fully compatible with accuracy specifications and with all Absolute Arm models.

### Delivery contents

- Mounting ring (ø 108 mm)
- All necessary mounting screws

8x12	✓*
83-6 / 85-6 / 87-6	✓
83-7 / 85-7 / 87-7	✓



H00012888

## Mounting Ring Adaptor Kit

Allows the use of any standard mounting base or tripod with RA8 Absolute Arm Compact models.

### Delivery contents

- Mounting interface
- Nut
- All necessary mounting screws

8x12	✓**
83-6 / 85-6 / 87-6	
83-7 / 85-7 / 87-7	



H00000896

## Magnetic Anchors

Magnetic anchors for the use with the integrated base of Absolute Arm Compact models.

### Delivery contents

- 3 magnetic anchors

### Remarks

Magnetic anchors are delivered as standard for all Absolute Arm Compact models



H00001346\*\*

## Magnetic Blocks and Anchors Kit

Magnetic blocks and anchors for the use with the integrated base of Absolute Arm Compact models.

### Includes

- 3 magnetic blocks (100 kg force/unit)
- 3 magnetic anchors
- All necessary mounting screws
- Short hexagon key



\* For 8x12 models a Mounting Ring Adaptor (H00012888) is required.

\*\* Option available only for 8x12 models.

# Tripods

Instrument stands for functionality and portability. Collapsible, tripod-type stands are available in a number of standard configurations. Stands with graphite upper legs have a low weight and give an advantage with respect to thermal stability. The height of the stand is adjusted by releasing quick-action levers and setting each telescoping leg to the desired length.

**H00011491 Hexagon Stand, Graphite Portable Adjustable (MGS2000SA)**

- Height adjustable 743-1403 mm
- Net weight: 18 kg
- Feet: 3 pad feet (32990) included

8x12	✓*
83-6 / 85-6 / 87-6	✓
83-7 / 85-7 / 87-7	✓



**H00011492 Hexagon Stand, Graphite Portable Fixed (MGS2000SF)**

- Height adjustable 619-972 mm
- Net weight: 16 kg
- Feet: 3 pad feet (32990) included

8x12	✓*
83-6 / 85-6 / 87-6	✓
83-7 / 85-7 / 87-7	✓



**H00011493 Hexagon Stand, Tetralock Portable - 400S-D**

- Materials: aluminium / stainless steel
- Height: adjustable 750-1190 mm
- Net weight: 11 kg
- Transport case: duffel-style canvas bag

8x12	✓*
83-6 / 85-6 / 87-6	✓
83-7 / 85-7 / 87-7	✓



**32990 Brunson Pad Feet for Graphite Portable Stands**

- For H00011492 (MxS2000SF), H00011491 (MxS2000SA) and H00011493 (400S-D)
- 3 pieces

**H00029348 Universal Power Supply Holder Kit**

to be fixed on tripod leg



**576905 Travel Case for Graphite Portable Stands**

Travel case for easy and safe transportation when shipping or packing requirements call for more protection, included carrying bag.

- For H00011491 and H00011492



**576906 Tripod Padded Bag**

Durable carrying bag for easy transport to and from the jobsite.

- For H00011491 and H00011492



\* For 8x12 models a Mounting Ring Adaptor (H00012888) is required.

# Stands

Rigid heavy-duty metrology stands are perfect for 3D measurement applications that require a great deal of stability along with mobility around the workplace.

**H00011496 Hexagon Stand, Model 230-F-24 Small**

- Height: fixed 610 mm
- Net weight: 77 kg

8x12	✓*
83-6 / 85-6 / 87-6	✓
83-7 / 85-7 / 87-7	✓



**H00011497 Hexagon Stand, Model 230-F-36 Medium**

- Height: fixed 910 mm
- Net weight: 86 kg

**H00011498 Hexagon Stand, Model 230-F-48 Large**

- Height: fixed 1220 mm
- Net weight: 104 kg

**H00011494 Hexagon Stand, Model 231 Small**

- Height: adjustable 710-1070 mm
- Net weight: 88 kg

8x12	✓*
83-6 / 85-6 / 87-6	✓
83-7 / 85-7 / 87-7	✓



**H00011495 Hexagon Stand, Model 230 Large**

- Height: adjustable 1090-1700 mm
- Net weight: 104 kg

**32004-1 Brunson Stand Extension 234-20**

- Height: 508 mm
- Includes spacer ring

8x12	✓*
83-6 / 85-6 / 87-6	✓
83-7 / 85-7 / 87-7	✓



**H00011499 Hexagon Laptop Support Arm and Tray 230-231**

Black laptop support stand with adjustable laptop support tray, power cable management clips and 2 power supply mounting brackets.

- Materials: aluminium (frame), plastic (tray)
- Max. keyboard thickness/width: 44 mm / 394 mm
- Net weight: 5 kg
- Portable: yes
- Transport case: no

8x12	✓*
83-6 / 85-6 / 87-6	✓
83-7 / 85-7 / 87-7	✓



\* For 8x12 models a Mounting Ring Adaptor (H00012888) is required.

# Tables

Hexagon portable base stations provide the ideal workplace for your portable measuring arm. Available in a number of sizes and configurations, they have a rigid design and are fully rust proofed. Stable, lockable wheels and a convenient handle allows for easy movement and secure stowing. Lockable doors and drawers are designed to store frequently used inspection tools, accessories and other components safely. The M8 threaded top plate is magnetic, allowing the arm to be mounted directly. The 50-millimetre hole pitch ensures maximum flexibility and freedom in setting up the right fixture for every part. Each base station is equipped with a Swift-Fix Basic kit (pictured) as standard, enabling operators to correctly fixture parts of different shapes, sizes and complexity.



Swift-Fix Basic Kit

Available in two sizes, each with two configurations: two doors and one drawer or two large drawers. Maximum workload capacity of all configurations is 250 kg. Two-draw versions available with foam insert for Absolute Arm Compact models. Skeleton versions available with option of stable feet or lockable wheels. Dimensional indications (W x D x H) in mm.

GB0005-2014	<b>Version two doors, one drawer</b>	910 x 610 x 935	115 kg net
GB0005-2015	<b>Version two doors, one drawer</b>	1220 x 910 x 935	196 kg net
GB0005-2016	<b>Version two drawers</b>	910 x 610 x 935	115 kg net
GB0005-2024	<b>Version two drawers</b> with foam insert for 8x12 arm	910 x 610 x 935	115 kg net
GB0005-2017	<b>Version two drawers</b>	1220 x 910 x 935	196 kg net
GB0005-2025	<b>Version two drawers</b> with foam insert for 8x20 arm	1220 x 910 x 935	196 kg net
GB0005-2050	<b>Version two drawers</b> with foam insert for 8x25 arm	1380 x 910 x 935	210 kg net
GB0005-2011	<b>Skeleton version on stable feet</b>	910 x 610 x 935	250 kg net
GB0005-2007	<b>Skeleton version on lockable wheels</b>	1820 x 610 x 935	250 kg net
GB0005-2008	<b>Skeleton version on lockable wheels</b>	1830 x 910 x 935	250 kg net
GB0005-0026	<b>Ratchet Jackable castors (set of 4)</b> when ordered with a base station		
GB0005-0050	<b>Ratchet Jackable castors (set of 4)</b> when ordered with an upgrade		



Version two doors, one drawer



Version two drawers



Skeleton example



GB0005-0024 **Laptop mount**  
for laptop up to 15" option

GB0005-0020 **Laptop mount**  
for laptop up to 17" option

H00002365 **Tube Inspection Table**  
Table dedicated for tube inspection applications.

1854 x 1230 x 917 100 kg net

*Compatible with*

- Mounting ring
- Stands (NCA7-5-52794 and NCA 7-5-52795)
- M6 holes grid



## Raisers

Stable height extension for any arm. Particularly suitable for Absolute Arm tube inspection systems.

NCA7-5-52794 **Arm Raiser – 250 mm**  
Multi-purpose stand, suitable for Absolute Arm tube stations as well as other high-accuracy arm applications.

- Compatible with accuracy specifications
- Compatible with all sizes of arm
- Mounting Ring included
- Height: 250 mm



NCA7-5-52795 **Arm Raiser – 500 mm**  
Multi-purpose stand, suitable for Absolute Arm tube stations as well as other high-accuracy arm applications.

- Compatible with accuracy specifications
- Compatible with all sizes of arm
- Mounting Ring included
- Height: 500 mm





# Artefacts and certifications

Verification bars	48
Certified spheres	49
Artefacts for tube probes	50
Optional certifications	51

# Verification bars

Certified length bars are mainly used to verify the accuracy of portable measuring arms and to perform length checkouts. They can also be used to evaluate arm performance against ISO 10360-12, ASME B89.4.22 or VDI/VDE standards.

32377\*

## Certified Length Bar (short)

This length bar is recommended for 1.2 m Absolute Arm models.

Lengths

L1: 170 mm

L2: 310 mm

*Delivery contents*

Certified length bar

DIN ISO-17025 certificate

32378\*

## Certified Length Bar (medium)

This length bar is recommended for 2.0-2.5 m Absolute Arm models.

Lengths

L1: 362 mm

L2: 712 mm

*Delivery contents*

Certified length bar

DIN ISO-17025 certificate

32379\*

## Certified Length Bar (long)

This length bar is recommended for 3.0-4.5 m Absolute Arm models.

Lengths

L1: 514 mm

L2: 1016 mm

*Delivery contents*

Certified length bar

DIN ISO-17025 certificate

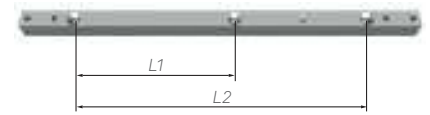

\* One included with all 85/87 Series arm packages, according to arm size.



# Certified spheres

Certified spheres are used to calibrate all contact probes and laser scanners or to verify their accuracy.

## NCA7-5-20653-01 Certified Sphere - Probing (25.4 mm)

- Already included with 6-axis and SE arms
- Sphere:  $\varnothing$  25.4 mm / hardness 58 Rc
- Material: high-chrome high-carbon stainless steel
- Certificate and base plate included

8x12	<input checked="" type="checkbox"/>
83-6 / 85-6 / 87-6	<input checked="" type="checkbox"/>
83-7 / 85-7 / 87-7	<input checked="" type="checkbox"/>



## H00000347 Certified Sphere - Scanning and Probing (25.4 mm)

- Recommended for scanning systems
- Already included with RS5 and AS1 kits
- Sphere:  $\varnothing$  25.4 mm
- Material: Tungsten carbide with matte finish
- Certificate and base plate included

8x12	<input type="checkbox"/>
83-6 / 85-6 / 87-6	<input type="checkbox"/>
83-7 / 85-7 / 87-7	<input checked="" type="checkbox"/>



## H00016402 Certified Sphere for RS-SQUARED Area Scanner (75 mm)

- Certified sphere for checking RS-SQUARED Area Scanner
- Sphere:  $\varnothing$  75 mm
- Material: Aluminium alloy with coating finish
- Certificate and based plate included

8x12	<input type="checkbox"/>
83-6 / 85-6 / 87-6	<input type="checkbox"/>
83-7 / 85-7 / 87-7	<input checked="" type="checkbox"/>



# Artefacts for tube probes

Calibrate tube probes and evaluate tube probe accuracy against certified tools.

8x12	✓
83-6 / 85-6 / 87-6	✓
83-7 / 85-7 / 87-7	✓

- NCA7-2-21953-01 Calibration Artefact for Tube Probe (ø 6.4 mm)**  
 Quarter-inch diameter T-bar for non-contact tube probe alignment.  
 - Recommended for NCP1 and NCP2  
 - Certificate included

- NCA7-2-21953-02 Calibration Artefact for Tube Probe (ø 12.7 mm)**  
 Half-inch diameter T-bar for non-contact tube probe alignment.  
 - Recommended for NCP3 and NCP4  
 - Certificate included

- NCA7-2-21953-03 Calibration Artefact for Tube Probe (ø 25.4 mm)**  
 One-inch diameter T-bar for non-contact tube probe alignment.  
 - Recommended for NCP5 and NCP6  
 - Certificate included



- NCA7-2-21954-01 Z Gage for Tube Probe (ø 8 mm)**  
 Gauge for non-contact tube probe verification and certification.  
 - Recommended for NCP1 and NCP2  
 - Certificate included

- NCA7-2-21954-02 Z Gage for Tube Probe (ø 20 mm)**  
 Gauge for non-contact tube probe verification and certification.  
 - Recommended for NCP3 and NCP4  
 - Certificate included

- NCA7-2-21954-03 Z Gage for Tube Probe (ø 40 mm)**  
 Gauge for non-contact tube probe verification and certification.  
 - Recommended for NCP5 and NCP6  
 - Certificate included



# Optional certifications

H0000536 **Certification – ISO 10360-12**  
 Certification according to standard definition for tactile probing measurement with an articulated arm CMM.

8x12	<input checked="" type="checkbox"/>
83-6 / 85-6 / 87-6	<input checked="" type="checkbox"/>
83-7 / 85-7 / 87-7	<input checked="" type="checkbox"/>

H0000621 **Certification – B89.4.22**  
 Available only for RA7 models. Includes certification only (without recalibration).

H0000658 **Certification – ISO 10360-2**  
 Optional probing certification. Available only for 8x12 Absolute Arm Compact models.

8x12	opt
83-6 / 85-6 / 87-6	-
83-7 / 85-7 / 87-7	-

NCA7-4-52504 **Certification – VDI/VDE**  
 Available only for RA7 models. Probing certification according to standard definition.



# Accessories for tube inspection

Non-contact tube probes **54**

Tools **55**

Software and bender links **56**

# Non-contact tube probes

Infrared non-contact probes for tube measurement are available in 6 sizes, allowing measurement of all kinds of tubes. A laser dot (class 2M) guides the user for precise placement. Compatible with TubeShaper, GTube and Docs software.

8x12	✓
83-6 / 85-6 / 87-6	✓
83-7 / 85-7 / 87-7	✓

## NCA7-2-21952-01 NCP1 Non-Contact Tube Probe (12.5 mm)

∅	4-13 mm
T-bar*	∅ 6.4 mm (ref. NCA7-2-21953-01)
Z Gage*	∅ 8 mm (ref. NCA7-2-21954-01)

## NCA7-2-21952-02 NCP2 Non-Contact Tube Probe (25 mm)

∅	6-20 mm
T-bar*	∅ 6.4 mm (ref. NCA7-2-21953-01)
Z Gage*	∅ 8 mm (ref. NCA7-2-21954-01)

## NCA7-2-21952-03 NCP3 Non-Contact Tube Probe (50 mm)

∅	10-40 mm
T-bar*	∅ 12.7 mm (ref. NCA7-2-21953-02)
Z Gage*	∅ 20 mm (ref. NCA7-2-21954-02)

## NCA7-2-21952-04 NCP4 Non-Contact Tube Probe (75 mm)

∅	12-65 mm
T-bar*	∅ 12.7 mm (ref. NCA7-2-21953-02)
Z Gage*	∅ 20 mm (ref. NCA7-2-21954-02)

## NCA7-2-21952-05 NCP5 Non-Contact Tube Probe (100 mm)

∅	20-85 mm
T-bar*	∅ 25.4 mm (ref. NCA7-2-21953-03)
Z Gage*	∅ 40 mm (ref. NCA7-2-21954-03)

## NCA7-2-21952-06 NCP6 Non-Contact Tube Probe (150 mm)

∅	30-130 mm
Recommended T-bar*	∅ 25.4 mm (ref. NCA7-2-21953-03)
Recommended Z Gage*	∅ 40 mm (ref. NCA7-2-21954-03)



\* Certified T-bar for alignment and certified Z Gage for verification not included.

# Tools

EBD-12865

**Tube Holder (ø 0-20 mm)**

- Available in Europe, Middle East, Africa and South America
- Weight: 17 kg



EBD-12866

**Tube Holder (ø 20-70 mm)**

- Available in Europe, Middle East, Africa and South America
- Weight: 17 kg

EBD-20539-4

**Tube Holder (ø 0-50 mm)**

- Available in North America, China and Asia-Pacific
- Weight: 10 kg



# Software and bender links

## BendingStudio

The BendingStudio software platform links all data and processes around the production of bended parts – from design and process planning to manufacturing and quality control. BendingStudio is the only tool to meet and combine these requirements with an emphasis on metrological processes.

With clear actual-nominal value comparison allowing for fast evaluation, the implementation of multiple inspection plans with individual measurement criteria for each part, and the presentation of results remaining the same no matter the origin of the data, BendingStudio is the complete package for complex analysis and management of tube and wire production.

With the capacity to work with measurement input from both TubeInspect and Absolute Arm systems, BendingStudio is a key part of any tube and wire manufacturing toolkit.

Please refer to page 78/79 for further information about software packages.

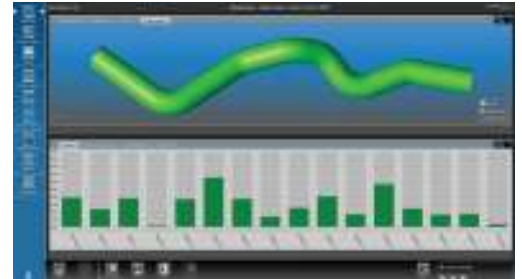



# Software and bender links

## TubeShaper

Created specifically for the Absolute Arm, TubeShaper brings user-friendly inspection to the tube manufacturing sector.

Designed to maximise production efficiency and reduce scrap, features such as offline licensing, direct import of CAD models and an intuitive modern graphical interface allow tubes to be designed, checked and corrected with speed and precision. Direct connection to a wide range of CNC tube bending machines from the market's leading manufacturers ensure that bending corrections are applied in real time on the shop floor.

Offering a state-of-the-art user interface, TubeShaper enables users to fully harness the measurement power and versatility of the Absolute Arm for all tube inspection applications. Non-contact infrared tube probes allow even soft rubber tubes to be measured, while tactile probes can also be used to reverse engineer or inspect complete tube fixtures. Uniquely, TubeShaper also allows for the measurement of rectangle-section tubes.

TubeShaper is the product of over three decades of experience in tube inspection and was developed in close collaboration with some of the world's leading tube manufacturers. Tube measurement software has never been so complete.

Please refer to page 80/81 for further information about software packages,



*Monitor not included.*





# Volume extension systems

GridLOK

60

Leap Frog Kit

61

# GridLOK

GridLOK is an expanded measurement solution that allows the accuracy and convenience of the Absolute Arm to be applied to larger parts and systems otherwise beyond its reach.

8x12	
83-6 / 85-6 / 87-6	✓
83-7 / 85-7 / 87-7	✓



51460-XX

## GridLOK Installation

- Please specify the grid size when you order the kit
- Grid pattern available from 4 by 6 m up to 60 by 60 m\*
- Please consult your local Hexagon representative for further information and recommendations

11615

## GridLOK stand-alone license

Dongle-protection to activate the use of GridLOK function.

\* Specific measuring area can be evaluated on request.

# Leap Frog Kit

A set of magnets used to align an Absolute Arm across multiple measurement stations when measuring larger parts.

8x12	✓
83-6 / 85-6 / 87-6	✓
83-7 / 85-7 / 87-7	✓

54479-01

## Leap Frog kit

Delivered in storage box.

- 4x Magnets with cones
- 1x Short rod





# Other accessories

Cables and adaptors 64

Control packs 65

Batteries 66

Dust covers 67

Installation USB 67

Vision solutions 69

# Cables and adaptors

H00017063

## Gigabit Ethernet Adaptor

Ethernet to USB adaptor, for users who prefer a USB connection to Ethernet.

8x12	✓
83-6 / 85-6 / 87-6	✓
83-7 / 85-7 / 87-7	✓



H00003263

## ODU-Ethernet cable (3 m)

3-metre long Ethernet cable for arm-to-computer data transfer and scanner data transfer. For use with all RA8 Absolute Arm models.

8x12	✓
83-6 / 85-6 / 87-6	✓
83-7 / 85-7 / 87-7	✓



H00008521

## ODU-Ethernet cable (5 m)

5-metre long Ethernet cable for arm-to-computer data transfer and scanner data transfer. For use with all RA8 Absolute Arm models.

8x12	✓
83-6 / 85-6 / 87-6	✓
83-7 / 85-7 / 87-7	✓





# Control packs

Every advanced function an Absolute Arm performs is mediated through a control pack. From power, probing and scanning over a single cable connection to hot-swappable batteries and full-speed measurement-over-WiFi for unmatched portability, it all comes down to the control pack.

H00016653

## CP-C, Accessory

Connector Pack (CP-C) shipped individually in shipping box.

8x12	✓
83-6 / 85-6 / 87-6	✓
83-7 / 85-7 / 87-7	✓

- Single cable connection for all touch probes, tube probes and scanners (HP-L-8.9, HP-C-V3D, AS1, RS5 and RS-SQUARED)
- Connection over ethernet or USB (with adaptor)

### Includes

- Connector Pack CP-C
- RDS maintenance and interface software
- ODU-Ethernet cable-3m.
- Ethernet Gigabit adaptor.

Warning: Not compatible with HP-L-20.8 Laser Scanner

H00016654

## CP-W, Accessory

Wireless Pack (CP-W) shipped individually in shipping box.

8x12	✓
83-6 / 85-6 / 87-6	✓
83-7 / 85-7 / 87-7	✓

- Single cable connection for all touch probes, tube probes and scanners (HP-L-8.9, HP-C-V3D, AS1, RS5 and RS-SQUARED)
- Wireless connections for all touch probes, tube probes, AS1, RS5 and RS-SQUARED. (HP-L-8.9 and HP-C-V3D do not support wireless connections)
- Connection over ethernet or USB (with adaptor)
- Battery operation (with hot-swappable batteries)

### Includes

- Wireless Pack CP-W
- RDS maintenance and interface software
- Two rechargeable batteries
- ODU-Ethernet cable (3 m)
- Ethernet gigabit adaptor

Warning: Not compatible with HP-L-20.8 Laser Scanner



# Batteries

NCA7-6-50108 **Li-ion Battery**  
Internal Lithium-ion battery. A second battery can be hot-swapped with the battery installed in the control pack to allow constant powered wireless usage with no downtime. For all Absolute Arm Series 8 models equipped with a Wireless Pack CP-W, Control Pack 2 or Control Pack 3.



CH5000E **Charger for Li-ion Battery (EU)**  
External quick charger for Lithium-ion battery.

CH5000U **Charger for Li-ion battery (UK)**  
External quick charger for Lithium-ion battery.

CH5000A **Charger for Li-ion battery (US)**  
External quick charger for Lithium-ion battery.



H00007922 **RS-SQUARED Warming Plug**  
Permits advanced warmup and/or maintenance of operational temperature of RS-SQUARED Area Scanner while using Absolute Arm with other sensors.



*Includes*

- Warming plug
- Power supply

## Dust covers

Protection against dust is available for all Absolute Arm models and sizes. Designed to fit the arm when in the rest position.

H00006817 **Dust Cover – Hexagon branded (750 mm)**  
For Absolute Arm size 1.2 m

8x12	<input checked="" type="checkbox"/>
83-6 / 85-6 / 87-6	
83-7 / 85-7 / 87-7	



H00006816-01 **Dust Cover – Hexagon branded (1080 mm)**  
For Absolute Arm size 1.5-2 m

8x12	
83-6 / 85-6 / 87-6	<input checked="" type="checkbox"/>
83-7 / 85-7 / 87-7	<input checked="" type="checkbox"/>



H00006816-02 **Dust Cover – Hexagon branded (1280 mm)**  
For Absolute Arm size 2.5-3 m

8x12	
83-6 / 85-6 / 87-6	<input checked="" type="checkbox"/>
83-7 / 85-7 / 87-7	<input checked="" type="checkbox"/>



H00006816-03 **Dust Cover – Hexagon branded (1640 mm)**  
For Absolute Arm size 3.5-4.5 m

8x12	
83-6 / 85-6 / 87-6	<input checked="" type="checkbox"/>
83-7 / 85-7 / 87-7	<input checked="" type="checkbox"/>



## Installation USB package

H00007157 **USB Package Absolute Arm**  
Installation USB memory stick, including RDS installation files and all user manuals.

8x12	<input checked="" type="checkbox"/>
83-6 / 85-6 / 87-6	<input checked="" type="checkbox"/>
83-7 / 85-7 / 87-7	<input checked="" type="checkbox"/>



APODIUS VISION SENSOR

1000 #  
APODIUS VISION SENSOR  
# 1001



# Vision solutions

The first ever metrology solutions dedicated to carbon-fibre part applications, Hexagon's Vision System technology delivers camera-based analysis of composite fibre orientation.

HP-C-V2D-KIT

## HP-C-V2D Vision System

Standalone 2D carbon-fibre orientation analysis sensor. Shipped individually in shipping box.

### *Includes*

HP-C-V2D Vision Sensor; interface box with USB cable (3 m); sensor cable (5 m); power cord with adaptor (1.5 m); power cord with strands (3 m); user manuals; storage box; 2 carbon fibre sample sheet demo parts; and 12-month warranty.



HP-C-V3D-KIT-RA8

## HP-C-V3D Vision System for RA8

Carbon-fibre orientation analysis sensor that uses current generation Absolute Arm and laser scanner for 3D global coordinate referencing. Shipped individually in shipping box

### *Includes*

HP-C-V3D Vision Sensor; adapter for RA8 Absolute Arm [H00012103]; calibration kit; user manuals; storage box; carbon fibre 3D double dome demo part; and 12-month warranty.



HP-C-V3D-KIT

## HP-C-V3D Vision System for RA7

Carbon-fibre orientation analysis sensor that uses previous generation Absolute Arm and laser scanner for 3D global coordinate referencing. Shipped individually in shipping box.

### *Includes*

HP-C-V3D Vision Sensor; connecting cable for RA7 Absolute Arm (3 m); connecting kit for sensor; calibration kit; user manuals; storage box; carbon fibre 3D double dome demo part; and 12-month warranty.



Slot2 Callout	
	Deviation
Center X	0.00307 ✓
Center Y	-0.00875 ✗
Center Z	0.00285 ✓
Length	0.08429 ✓
Width	0.04493 ✓



Circle3 Callout	
	Deviation
Center X	0.00329 ✓
Center Y	0.02048 ✗
Center Z	-0.00007 ✓
Diameter	0.01401 ✓

Slot1 Callout	
	Deviation
Center X	-0.00863 ✓
Center Y	-0.01908 ✗
Center Z	-0.00540 ✓
Length	0.09240 ✓
Width	0.08600 ✓

Circle1 Callout	
	Deviation
Center X	0.00651 ✓
Center Y	0.02002 ✗
Center Z	0.00192 ✓
Diameter	0.01040 ✓

Circle2 Callout	
	Deviation
Center X	-0.00117 ✓
Center Y	-0.02142 ✗
Center Z	0.00355 ✓
Diameter	0.01120 ✓

# Application software

PC-DMIS Portable 72

Inspire 74

SpatialAnalyzer 75

QUINDOS 76

APODIUS Explorer | VISI Reverse 77

BendingStudio 78

TubeShaper 80

# PC-DMIS Portable



Portable measurement devices have changed the way operations are monitored, making it possible to take measurements and analyse the results directly where parts are made and assembled. PC-DMIS Portable provides the tools needed to more effectively monitor operations and identify minor issues before they turn into costly problems.

ROY-PROBE	<b>PC-DMIS CAD++ Probing</b> Includes LMS license + all Portable interface (ROY-I-PORTABLE) + XACT GD&T + IGES / DXF / DWG / STEP203 / STEP 214 / VDAFS / XYZIJK / DES and DMISI/O translators and updates for 1 year
ROY-SCAN	<b>PC-DMIS CAD++ Scanning</b> Includes LMS license + All Portable interfaces (ROY-I-PORTABLE) + Hexagon Scanning Probe Interface + Scanning Auto Features + Full COP support + XACT GD&T + IGES / DXF / DWG / STEP203 / STEP 214 / VDAFS / XYZIJK / DES and DMISI/O translators and updates for 1 year.
ROY-SCANMESH	<b>PC-DMIS CAD++ Scanning/Mesh</b> Includes LMS license + all Portable interfaces (ROY-I-PORTABLE) + Hexagon Scanning Probe Interface + Scanning Auto Features + Full COP support + XACT GD&T, IGES / DXF / DWG / STEP203 / STEP 214 / VDAFS / XYZIJK / DES and DMISI/O translators + STL Mesh Creation and Inspection and updates for 1 year.
ROY-UP-300	<b>UPGRADE PC-DMIS CAD++ Probing to PC-DMIS CAD++ Scanning for use with RSx and AS1 scanners</b> Allows existing customers with a valid SMA to upgrade from PC-DMIS CAD++ Probing to PC-DMIS CAD++ Scanning.
ROY-UP-301	<b>UPGRADE PC-DMIS CAD++ Probing to PC-DMIS CAD++ Scanning for use with HP-L-20.8</b> Allows existing customers with a valid SMA to upgrade from PC-DMIS CAD++ Probing to PC-DMIS CAD++ Scanning.



# PC-DMIS Portable

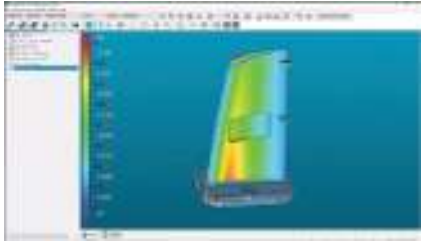

ROY-ADD-MESH	<p><b>UPGRADE PC-DMIS CAD++ Scanning to PC-DMIS CAD++ Scanning/Mesh</b>          Allows existing customers with a valid SMA to upgrade from PC-DMIS CAD++ Scanning to PC-DMIS CAD++ Scanning/Mesh.</p>
ROY-SMA-PROBE-I-A	<p><b>Annual SMA for CAD++ Scanning</b>          Annual Software Maintenance Agreement (SMA) after year 1.</p>
ROY-SMA-SCAN-I-A	<p><b>Annual SMA for CAD++ Scanning</b>          Annual Software Maintenance Agreement (SMA) after year 1.</p>
ROY-SMA-MESH-I-A	<p><b>Annual SMA for CAD++ Scanning/Mesh</b>          Annual Software Maintenance Agreement (SMA) after year 1.</p>

# Inspire



## User-friendly measurement software for portable probing and scanning

Inspire is the next generation inspection software for all portable probing and scanning devices. Inspire is a new software package that makes measurement simple and the complex possible. With one simple interface, Inspire works with laser tracker for probing and scanning applications. Intuitive and easy to use, Inspire software is a comprehensive solution that makes measurement simple, saves time, and ultimately improves productivity.

### *Inspire capabilities*

- Measure
- Align
- Assemble/Build
- Analyse
- Report
- Scan and Probe
- Mesh
- Instrument networking
- Advanced Scripting
- CAD Import



Single Seat Licence includes all hardware interfaces and supports IGES, STEP, STL, CATIA, Solidworks, NX, ProEngineer, Inventor and Parametric CAD import. Training classes available at additional cost and updates for 1 year. Inspire provided with licence code.

576741

**Inspire - Single Seat Licence**

# SpatialAnalyzer®



**Powerful and traceable measurement and analysis software**

SpatialAnalyzer® (SA) is a powerful, traceable and easy to use metrology and analysis software package, tailored for Hexagon’s Manufacturing Intelligence portable CMM family.

- SA offers a vast number of benefits, including:
- Intuitive, state of the art graphical environment.
  - Interfaces to all Hexagon Manufacturing Intelligence portable CMMs.
  - All common CAD exchange and native formats.
  - Advanced analysis and processing and unique alignment techniques.
  - Easy multiple-instrument station bundling.
  - True GD&T and feature checks.
  - Numerous reporting options.
  - Measurement uncertainty calculation.
  - Unified Spatial Metrology Network to achieve the ideal instrument network.
  - Integrated Modern Scripting Language to automate complete workflows.
  - Multiple language support.
  - Free SA Viewer to share SA job files easily.



*Monitor not included.*

SpatialAnalyzer® makes metrology easy.

SA PRO	<b>SA Professional</b>
SA UL	<b>SA Ultimate</b>
	Upgrades
576737	<b>Upgrade from SA PRO to SA UL</b>
	Maintenance
SA PRO EXT	<b>SMA for SA Professional</b>
SA UL EXT	<b>SMA for SA Ultimate</b>

# QUINDOS



MTW-510-QPG-001

## **Gear Software Package for Portable Products**

- Quindos 7 Basic (incl. CAD basic for scannable portable devices).
- Gear (measurement of straight or helical (cylindrical) gears.
- Unknown Gear (inspection of straight and helical, external and internal gears or gears segment with unknown parameters

Attention: When using the Absolute Arm for larger applications, an extension of the measuring volume may be required. Note that the required length must be adapted to the gear size.

# APODIUS Explorer



**The uniquely specialised composite fibre orientation analysis platform**

An innovative and intuitive real-time software solution designed specifically for handling the unique challenges of composite scanning and fibre orientation analysis. Supports both manual and automated analysis processes.

**HP-C-V2D-DONGLE-STD HP-C-V2D APODIUS Explorer 2D Software**  
Includes HP-C-V2D software dongle and single-user licence. First year SMA included.

**HP-C-V3D-DONGLE-STD HP-C-V3D APODIUS Explorer 3D Software**  
Includes HP-C-V3D software dongle and single-user licence. First year SMA included.

**HP-C-V2D-SW-1Y-SMA APODIUS Explorer 2D Software Maintenance Extension - 1 Year**

**HP-C-V3D-SW-1Y-SMA APODIUS Explorer 3D Software Maintenance Extension - 1 Year**

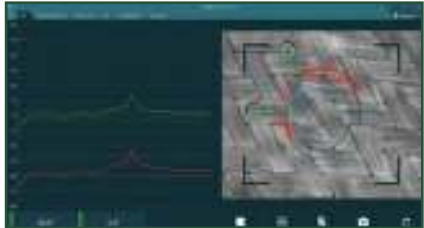

# VISI Reverse



**VS-B10A Cloud to Mesh**  
Allows imported scan data (from file or directly from a Hexagon scanner) to be converted into a refined mesh (noise reduction, filtering, smoothing, topology detection, re-alignment). Mesh data can then be used as is or as a reference model for curves extraction. Direct interface to Absolute Arm included.

Attention: Other prerequisite module(s) (VS-B03B / VS-S020) required. Please consult your local Hexagon representative for a complete overview and compatibility information.

**VS-B10B Mesh to Surface**  
Allows mesh models to be converted automatically or semi-automatically to analytical surfaces.

Attention: Other prerequisite module(s) (VS-B10A) required. Please consult your local Hexagon representative for a complete overview and compatibility information.

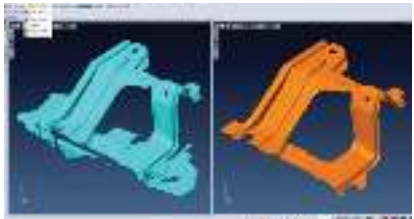

# BendingStudio



## The complete platform for bending data and processes

Bendingstudio links all data and processes involved in the manufacture of bended parts, from production and process planning to manufacture and quality control.

110852

### **BendingStudio EFFICIENT**

Compatible with TubeInspect and Absolute Arm with laser scanner (RDS) measurement systems.

*Functionality includes:*

- Database
- Optical gauge
- Bend data
- Bender interface standard
- Reverse engineering
- Statistics and reporting



110853

### **BendingStudio TUBE**

Compatible with TubeInspect and Absolute Arm with laser scanner (RDS) measurement systems.

*Functionality includes:*

- Database
- Optical gauge
- Bend data
- Bender interface standard
- Reverse engineering
- Statistics and reporting
- Functional dimension
- Deflection dimension
- Formed ends diameter change adaptor

110854

### **BendingStudio WIRE**

Compatible with TubeInspect and Absolute Arm with laser scanner (RDS) measurement systems.

*Functionality includes:*

- Database
- Optical gauge
- Bend data
- Bender interface standard
- Reverse engineering
- Statistics and reporting
- Functional dimension
- Deflection dimension
- Bender interface freeform

# BendingStudio

110855	<p><b>BendingStudio PROFESSIONAL</b> Compatible with TubeInspect and Absolute Arm with laser scanner (RDS) measurement systems.</p> <p><i>Functionality includes:</i></p> <ul style="list-style-type: none"> <li>- Database</li> <li>- Optical gauge</li> <li>- Bend data</li> <li>- Bender interface standard</li> <li>- Reverse engineering</li> <li>- Statistics and reporting</li> <li>- Functional dimension</li> <li>- Deflection dimension</li> <li>- Formed ends diameter change adaptor</li> <li>- Bender interface freeform</li> <li>- Branched tubes</li> <li>- Hoses</li> </ul>
110856	<b>Upgrade EFFICIENT to TUBE</b>
110857	<b>Upgrade EFFICIENT to WIRE</b>
110858	<b>Upgrade TUBE to PROFESSIONAL</b>
110859	<b>Upgrade WIRE to PROFESSIONAL</b>
110860	<b>TubeInspect CONTROLLER</b>
106484	<b>BendingStudio CAD-WIZARD</b>
106488	<p><b>BendingStudio OFFLINE Licence</b> Same modules as main licence but without interface to measurement system. Applicable also for extension of network licence (ART110874) with 1 additional user.</p>
110874	<p><b>BendingStudio OFFLINE Network Licence</b> Same modules as main licence but without interface to measurement system, Network licence for 1 user only; licences for further users on request</p>
106489	<b>BendingStudio Network Service</b>
109654	<b>1Y-SMA BendingStudio OFFLINE</b>
110826	<b>3Y-SMA BendingStudio OFFLINE</b>
110321	<b>1Y-SMA BendingStudio and Absolute Arm with Scanner</b>
110827	<b>3Y-SMA BendingStudio and Absolute Arm with Scanner</b>



# TubeShaper



## Specialist software for tube measurement, gauging and bending machine control

Created specifically for the Absolute Arm, TubeShaper brings a combination of user-friendly inspection and advanced functionality to the tube manufacturing sector.

The TubeShaper licensing concept allows TubeShaper to be configured by combining the three modules in several ways. There are effectively 4 possible configurations:

1. TubeShaper with no arm or bender interface  
(H00017742)
2. TubeShaper with arm interface, but no bender interface  
(H00017742 + H00017744)
3. TubeShaper with bender interface, but no arm interface  
(H00017742 + H00017743)
4. TubeShaper with both arm and bender interfaces  
(H00017742 + H00017743 + H00017744)



Monitor not included.



# TubeShaper

H00017742	<p><b>TubeShaper, Core Licence</b></p> <p>Includes all functionality, but no connection to any arm or bender. First year SMA included.</p>
H00017743	<p><b>TubeShaper, Arm Measurement Module</b></p> <p>Allows for connection to and collection of measurement data with any Absolute Arm or other RDS compatible arm. Supports all touch probes and tube probes. Must be added to a TubeShaper Core Licence.</p>
H00017744*	<p><b>TubeShaper, Bender Link</b></p> <p>Interface for connecting to 1 compatible bending machine. Warning: TubeShaper version must be at least v2.0. Bender compatibility must be checked in advance (see TubeShaper bender compatibility guide).</p>
ROY-SMA-TUBE	<p><b>Annual SMA after Year 1</b></p> <p>Software Maintenance Agreement (SMA) provides access to software updates and unlimited technical support.</p>
H00017746	<p><b>Upgrade from G-Tube to TubeShaper without Bender Interface</b></p> <p>G-Tube dongle will be required</p>
H00017747*	<p><b>Upgrade from DOCS (without SMA) to TubeShaper with 1 Bender Interface.</b></p> <p>DOCS dongle will be required.</p>
H00017749	<p><b>Upgrade from SUPRAVISION to TubeShaper without Bender Interface.</b></p> <p>Supravisision dongle will be required.</p>

\* Please consult your local Hexagon representative for a complete and up-to-date list of available CNC tube bender interfaces.



# Warranty and maintenance

Warranty plan renewals **84**

Customer Care Packages **86**

# Warranty plan renewals

H00011149-01*	<b>1 Year Arm Warranty Extension</b> Renewal of standard manufacturer's warranty plan for Absolute Arm range for 1 year.
H00011149-02*	<b>2 Years Arm Warranty Extension</b> Renewal of standard manufacturer's warranty plan for Absolute Arm range for 2 years.
H00011149-03*	<b>3 Years Arm Warranty Extension</b> Renewal of standard manufacturer's warranty plan for Absolute Arm range for 3 years.
H00011150-01*	<b>1 Year RS5 Warranty Extension</b> Renewal of standard manufacturer warranty plan for RS5 Laser Scanner for 1 year.
H00011150-02*	<b>2 Years RS5 Warranty Extension</b> Renewal of standard manufacturer warranty plan for RS5 Laser Scanner for 2 years.
H00011150-03*	<b>3 Years RS5 Warranty Extension</b> Renewal of standard manufacturer warranty plan for RS5 Laser Scanner for 3 years.
RS6-ASx-HW-1Y-WRTY*	<b>1 Year RS6-ASx-Warranty Extension</b> Renewal of standard manufacturer warranty plan for RS6 and AS1 Laser Scanner for 1 year.
RS6-ASx-HW-2Y-WRTY*	<b>2 Years RS6-ASx-Warranty Extension</b> Renewal of standard manufacturer warranty plan for RS6 and AS1 Laser Scanner for 2 years.
RS6-ASx-HW-3Y-WRTY*	<b>3 Years RS6-ASx-Warranty Extension</b> Renewal of standard manufacturer warranty plan for RS6 and AS1 Laser Scanner for 3 years.
H00018289-01*	<b>1 Year Area Scanner Warranty Extension</b> Renewal of standard manufacturer warranty plan for RS-SQUARED Area Scanner for 1 year.
H00018289-02*	<b>2 Years Area Scanner Warranty Extension</b> Renewal of standard manufacturer warranty plan for RS-SQUARED Area Scanner for 2 years.
H00018289-03*	<b>3 Years Area Scanner Warranty Extension</b> Renewal of standard manufacturer warranty plan for RS-SQUARED Area Scanner for 3 years.
HP-C-V2D-HW-1Y-WRTY**	<b>Vision Sensor 2D 1-Year Warranty Plan Renewal</b> Including calibration and certification of the sensor. Must be ordered within eight (8) weeks of initial purchase. Can be purchased twice to extend the warranty from the first year (included) up to three (3) years.
HP-C-V3D-HW-1Y-WRTY**	<b>Vision Sensor 3D 1-Year Warranty Plan Renewal</b> Including calibration and certification of the sensor. Must be ordered within eight (8) weeks of initial purchase. Can be purchased twice to extend the warranty from the first year (included) up to three (3) years.

\* Can be added as an option before the first 24 months of standard warranty have expired.

\*\* Renewal of standard manufacturer warranty plan for Vision Sensor 2D and 3D for 1 year. Includes calibration and certification of the sensor.

# Warranty plan conditions

## Standard manufacturer warranty plan

Hexagon's portable measuring arm factories provide a 2-year manufacturer warranty for Hexagon arms and scanners (excluding the HP-L-8.9 and HP-L-20.8 laser scanners). Warranty period begins at the customer delivery date or 3 months after the factory delivery to the local Hexagon representative. Standard factory warranty plan renewals have the following terms:

1. Repair of manufacturing defects on the following components: arm, encoders, encoder board, electronic boards, probe, scanner optics and light source (excluding HP-L-8.9 and HP-L-20.8) and all other arm parts.
2. The warranty of two (2) years is valid only if an arm service check is performed during the first year. This is a paid service that must be purchased by the customer at some time between the arm delivery and the due date, meaning maximum one (1) year after the instrument delivery.
3. Unlimited telephone and email technical support during the warranty period.
4. Under normal usage, the carbon-graphite tubes have a lifetime warranty.
5. Customer assumes all shipping costs.

## Renewal of standard manufacturer warranty plan

Hexagon's portable measuring arm factories offer 1, 2, or 3-year renewals for the standard factory warranty plan. To be eligible for renewal, the warranty plan renewal must be ordered with the instrument or ordered before the existing warranty plan expires. Standard factory warranty plan renewals have the following terms:

1. Replacement or repair, at Hexagon portable measuring arm factory's discretion, free of charge, of any component or parts of the instrument which upon examination are found defective in workmanship or material.
2. Any required repairs not covered by the warranty plan renewal cost extra.
3. The instrument must be returned to the factory or an authorised and certified Hexagon service centre if a repair, calibration or certification needs to be performed.
4. For the renewals of the warranty, the instrument must be calibrated in a certified service centre, in the first instance no later than 15 months after delivery. The following calibrations are then required to take place every 12 months according to the warranty plan renewal.
5. Customer assumes all shipping costs.

# World-class service made simple

## Customer Care Packages

Owners of Hexagon products featured in this catalogue have the opportunity to invest in a Customer Care Package – a standardised after-sale service package designed to ensure equipment remains in top condition and can be relied upon for accurate measurement results.

- Maintenance and warranty plans that ensure top equipment availability
- Trouble-free usage and minimal downtime.
- Preferred hotline access at no additional cost
- Access to professional advice whenever it's needed

Customer Care Packages include a selection of the following benefits, depending on the tier chosen.

- Planned annual service
- Hardware support
- Annual maintenance and recertification
- Remote assistance
- Repair parts and labour
- Customised local benefits
- Software maintenance

For complete details of the benefits of each level of Customer Care Package, please contact a local Hexagon representative.

# Absolute Arm Customer Care Packages

	Platinum*	Gold*	Silver*	Bronze*
Planned annual service	<input checked="" type="checkbox"/>	<input checked="" type="checkbox"/>	<input checked="" type="checkbox"/>	<input checked="" type="checkbox"/>
Customer hardware support	<input checked="" type="checkbox"/>	<input checked="" type="checkbox"/>	<input checked="" type="checkbox"/>	<input checked="" type="checkbox"/>
Annual maintenance and recertification	<input checked="" type="checkbox"/>	<input checked="" type="checkbox"/>	<input checked="" type="checkbox"/>	-
Remote connected assistance	<input checked="" type="checkbox"/>	<input checked="" type="checkbox"/>	-	-
Repair parts and labour	<input checked="" type="checkbox"/>	-	-	-
Local customised benefits	<input checked="" type="checkbox"/>	<input checked="" type="checkbox"/>	<input checked="" type="checkbox"/>	<input checked="" type="checkbox"/>

All packages below can be added as an option before the first 12 months of standard warranty have expired.

H00029362	Bronze Customer Care Package
H00029363	Silver Customer Care Package
H00029364	Gold Customer Care Package
H00029365	Platinum Customer Care Package
H00028796	Upgrade Bronze to Platinum Customer Care Package
H00030198	Year 3 Platinum CCP
H00030199	Year 3 and 4 Platinum CCP
H00030200	Year 3, 4 and 5 Platinum CCP

\* For further information about Bronze, Silver, Gold and Platinum service contracts, please contact a local Hexagon representative.

## World-class products to rely on

Drawing on decades of research and development experience, metrology technology from Hexagon's Manufacturing Intelligence division is built on a long history of outperforming technological innovation. Deriving quality from experience to drive productivity is what keeps Hexagon in front and able to deliver first-class solutions for industries around the world.

Along with the assurance of ten years of serviceability, owners of Hexagon portable and large-volume systems benefit from a 24-month factory warranty as standard – our guarantee that our technology will always meet the needs of our users.

## World-class support delivered locally

The international presence of Hexagon guarantees comprehensive aftersales support and services across the globe. With the largest dedicated service team of any metrology equipment manufacturer and an emphasis on locally delivered solutions, Hexagon is unmatched from service, repair, certification and calibration through operator training and software maintenance and upgrades.





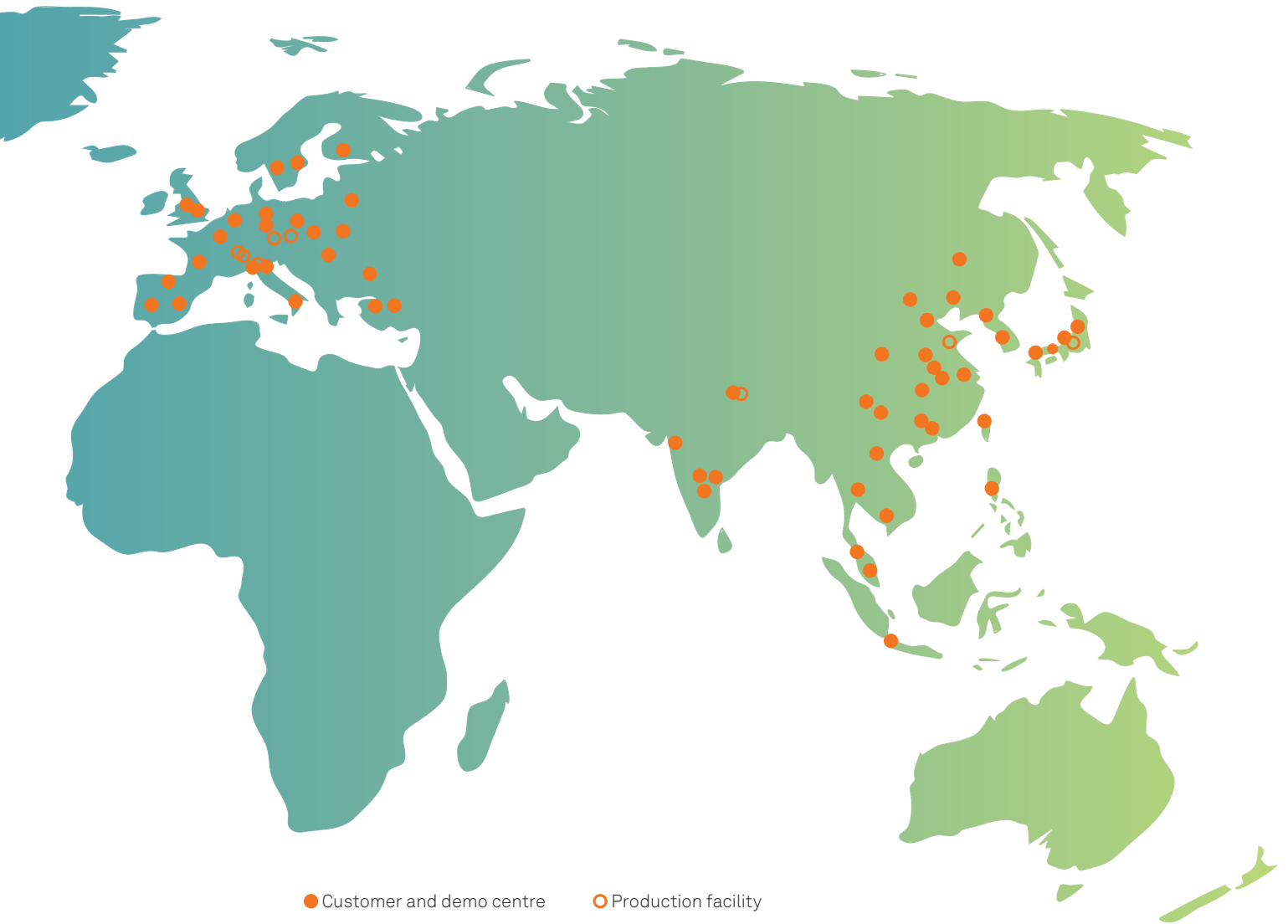



Hexagon is a global leader in sensor, software and autonomous solutions. We are putting data to work to boost efficiency, productivity, and quality across industrial, manufacturing, infrastructure, safety, and mobility applications.

Our technologies are shaping urban and production ecosystems to become increasingly connected and autonomous – ensuring a scalable, sustainable future.

Hexagon's Manufacturing Intelligence division provides solutions that utilise data from design and engineering, production and metrology to make manufacturing smarter. For more information, visit [hexagonmi.com](https://hexagonmi.com).

Learn more about Hexagon (Nasdaq Stockholm: HEXA B) at [hexagon.com](https://hexagon.com) and follow us [@HexagonAB](https://twitter.com/HexagonAB).